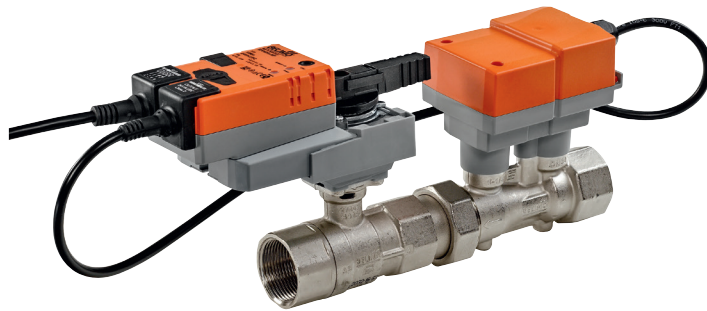

Communicative characterised control valve with sensor-operated flow control, 2-way, Internal thread, PN 16 (EPIV),

- Nominal voltage AC/DC 24 V
- Control modulating, communicative, hybrid mode
- For closed cold and warm water systems
- For modulating control of air-handling and heating systems on the water side
- Communication via BACnet MS/TP, Modbus RTU, Belimo-MP-Bus or conventional control
- Conversion of active sensor signals and switching contacts

Type overview

Type	DN []	Rp [“]	Vnom [l/s]	Vnom [l/min]	kvs theor. [m ³ /h]	PN []	n(gl) []
EP015R+MOD	15	1/2	0.35	21	2.9	16	3.2
EP020R+MOD	20	3/4	0.65	39	4.9	16	3.2
EP025R+MOD	25	1	1.15	69	8.6	16	3.2
EP032R+MOD	32	1 1/4	1.8	108	14.2	16	3.2
EP040R+MOD	40	1 1/2	2.5	150	21.3	16	3.2
EP050R+MOD	50	2	4.8	288	32.0	16	3.2

kvs theor.: Theoretical kvs value for pressure drop calculation

Technical data

Electrical data	Nominal voltage	AC/DC 24 V
	Nominal voltage frequency	50/60 Hz
	Nominal voltage range	AC 19.2...28.8 V / DC 21.6...28.8 V
	Power consumption in operation	3.5 W (DN 15...25) 4.5 W (DN 32...50)
	Power consumption at rest	1.3W (DN 15...25) 1.4W (DN 32...50)
	Power consumption for wire sizing	6 VA (DN 15...25) 7 VA (DN 32...50)
	Connection supply / control	Cable 1 m, 6 x 0.75 mm ²
Functional data	Torque motor	5 Nm (DN 15...25) 10 Nm (DN 32...40) 20 Nm (DN 50)
	Communicative control	BACnet MS/TP Modbus RTU (ex works) MP-Bus
	Operating range Y	DC 2...10 V
	Operating range Y variable	DC 0.5...10 V
	Position feedback U	DC 2...10 V
	Position feedback U variable	Start point DC 0.5...8 V End point DC 2...10 V
	Sound power level motor	45 dB(A)
	Adjustable flow rate Vmax	30...100% of Vnom
	Control accuracy	±10% (of 25...100% Vnom)
	Control accuracy note	±6% (of 25...100% Vnom) @ 20 °C / Glycol 0% vol.
	Media	Cold and warm water, water with glycol up to max. 50% vol.
	Medium temperature	-10...120°C
	Permissible pressure ps	1600 kPa
	Closing pressure Δps	1400 kPa
Differential pressure Δpmax	350 kPa	
Differential pressure note	200 kPa for low-noise operation	

Technical data

Functional data	Flow characteristic	equal percentage (VDI/VDE 2178), optimised in the opening range (switchable to linear)
	Leakage rate	Leakage rate A, air-bubble-tight (EN 12266-1)
	Installation position	Upright to horizontal (in relation to the stem)
	Maintenance	Maintenance-free
	Manual override	with push-button, can be locked
Flow measurement	Measuring principle	Ultrasonic volumetric flow measurement
	Measuring accuracy	±6% (of 25...100% Vnom)
	Measuring accuracy note	±2% (of 25...100% Vnom) @ 20 °C / Glycol 0% vol.
	Min. flow measurement	1% of Vnom
Safety	Protection class IEC/EN	III Safety Extra-Low Voltage (SELV)
	Degree of protection IEC/EN	IP54
	EMC	CE according to 2014/30/EU
	Mode of operation	Type 1
	Rated impulse voltage supply / control	0.8 kV
	Control pollution degree	3
	Ambient temperature	-30...50 °C
	Non-operating temperature	-40...80 °C
Materials	Ambient humidity	Max. 95% r.h., non-condensing
	Measuring pipe	Brass body nickel-plated
	Closing element	Stainless steel
	Stem seal	O-ring EPDM

Safety notes



- This device has been designed for use in stationary heating, ventilation and air conditioning systems and must not be used outside the specified field of application, especially in aircraft or in any other airborne means of transport.
- Outdoor application: only possible in case that no (sea)water, snow, ice, insolation or aggressive gases interfere directly with the actuator and that is ensured that the ambient conditions remain at any time within the thresholds according to the data sheet.
- Only authorised specialists may carry out installation. All applicable legal or institutional installation regulations must be complied during installation.
- The connection between the control valve and the measuring tube should not be separated.
- The device contains electrical and electronic components and must not be disposed of as household refuse. All locally valid regulations and requirements must be observed.

Product features

Mode of operation The final controlling device is comprised of three components: characterised control valve (CCV), measuring pipe with volumetric flow sensor and the actuator itself. The adjusted maximum flow (\dot{V}_{max}) is assigned to the maximum positioning signal (typically 100%). The final controlling device can be controlled communicative. The medium is detected by the sensor in the measuring pipe and is applied as the flow value. The measured value is balanced with the setpoint. The actuator corrects the deviation by changing the valve position. The angle of rotation α varies according to the differential pressure through the final controlling element (see volumetric flow curves).

Product features

Flow characteristic

Flow rate curves

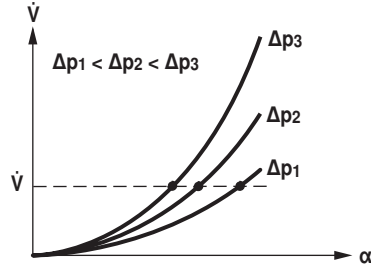

Transmission behaviour HE

Heat exchanger transmission behaviour

Depending on the construction, temperature spread, medium and hydraulic circuit, the power Q is not proportional to the water volumetric flow \dot{V} (Curve 1). With the classical type of temperature control, an attempt is made to maintain the control signal Y proportional to the power Q (Curve 2). This is achieved by means of an equal-percentage valve characteristic curve (Curve 3).

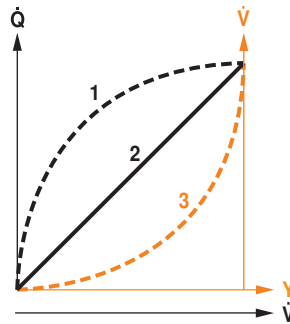

Product features

Control characteristics

The medium velocity is measured in the measuring component (sensor electronics) and converted into a flow rate signal. The positioning signal Y corresponds to the power requirement Q at the exchanger. The volumetric flow is regulated in the EPIV. The positioning signal Y is converted into an equal-percentage characteristic curve and provided with the \dot{V}_{max} value as the new reference variable w. The momentary control deviation forms the positioning signal Y1 for the actuator. The specially configured control parameters in conjunction with the precise flow rate sensor ensures a stable control quality. They are however not suitable for rapid control processes, i.e. for domestic water control. The measured flow rate is in l/min as an absolute volumetric flow output. The absolute position sets the valve opening angle in %. The relative position always refers to the nominal flow \dot{V}_{nom} , i.e. if \dot{V}_{max} is configured with 50% of \dot{V}_{nom} , then the relative position at a setpoint of 100% is equal to 50% of \dot{V}_{nom} .

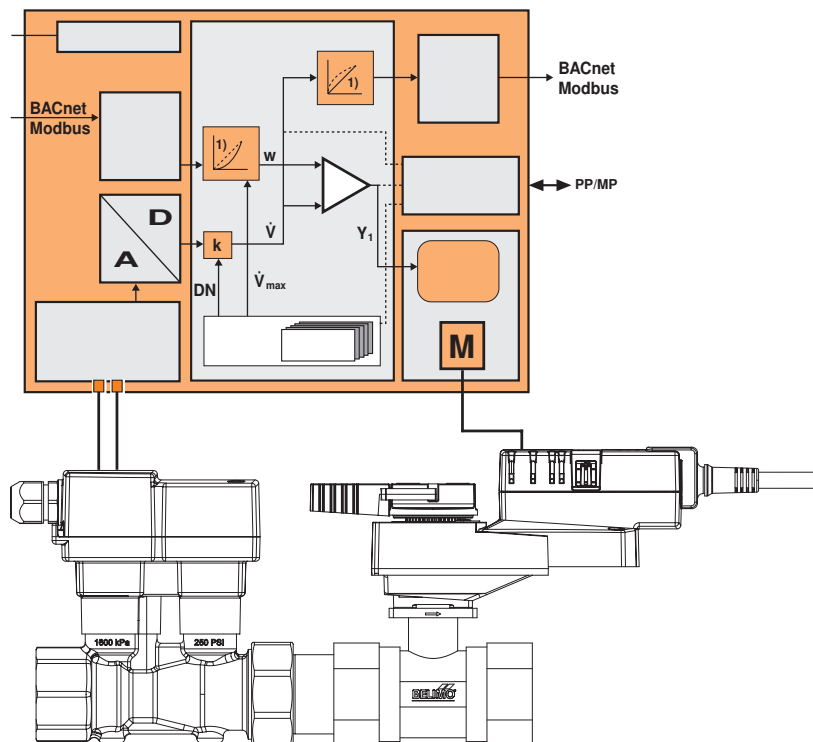
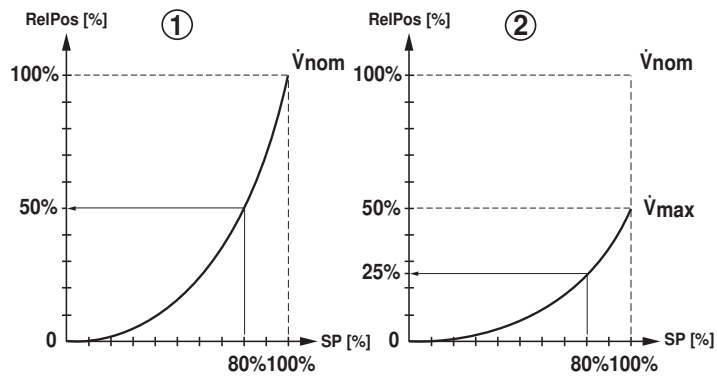

Product features

Definition Flow control
 \dot{V}_{nom} is the maximum possible flow.

\dot{V}_{max} is the maximum flow rate which has been set with the greatest positioning signal. \dot{V}_{max} can be set between 30% and 100% of \dot{V}_{nom} .

\dot{V}_{min} 0% (non-variable).

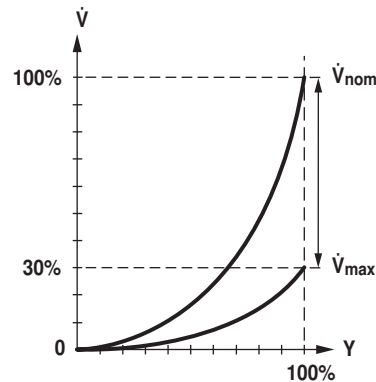

Creep flow suppression Given the very low flow speed in the opening point, this can no longer be measured by the sensor within the required tolerance. This range is overridden electronically.

Opening valve

The valve remains closed until the volumetric flow required by the positioning signal Y corresponds to 1% of \dot{V}_{nom} . The control along the valve characteristic curve is active after this value has been exceeded.

Closing valve

The control along the valve characteristic curve is active up to the required flow rate of 1% of \dot{V}_{nom} . Once the level falls below this value, the flow rate is maintained at 1% of \dot{V}_{nom} . If the level falls below the flow rate of 0.5% of \dot{V}_{nom} required by the reference variable Y , then the valve will close.

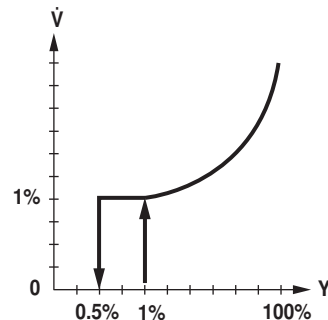

Converter for sensors Connection option for a sensor (active or with switching contact). In this way, the analogue sensor signal can be easily digitised and transferred to the bus systems BACnet, Modbus or MP-Bus.

Parameterisable actuators The factory settings cover the most common applications. Single parameters can be modified with the Belimo Service Tools MFT-P or ZTH EU. The communication parameters of the bus systems (address, baud rate etc.) are set with the ZTH EU. Pressing the "Address" button on the actuator while connecting the supply voltage, resets the communication parameters to the factory setting. Quick addressing: The BACnet and Modbus address can alternatively be set using the buttons on the actuator and selecting 1 to 16. The value selected is added to the «Basic address» parameter and results in the effective BACnet and Modbus address.

Hydraulic balancing With the Belimo tools, the maximum flow rate (equivalent to 100% requirement) can be adjusted on-site, simply and reliably, in a few steps. If the device is integrated in the management system, then the balancing can be handled directly by the management system.

Combination analogue - communicative (hybrid mode) With conventional control by means of an analogue positioning signal, BACnet or Modbus can be used for the communicative position feedback

Product features

- Manual override** Manual override with push-button possible (the gear is disengaged for as long as the button is pressed or remains locked).
- High functional reliability** The actuator is overload protected, requires no limit switches and automatically stops when the end stop is reached.

Accessories

	Description	Type
Electrical accessories	Connecting cable 5 m, A+B: RJ12 6/6, To ZTH EU	ZK1-GEN
	Connection cable 5 m, A: RJ11 6/4, B: Free wire end, To ZTH EU	ZK2-GEN
Service Tools	Description	Type
	Service tool for parametrisable and communicative Belimo actuators / VAV controller and HVAC performance devices	ZTH EU
	Belimo PC-Tool, software for adjustments and diagnostics	MFT-P
	Adapter to Service Tool ZTH	MFT-C

Electrical installation

Notes

- Connection via safety isolating transformer.
- The wiring of the line for BACnet MS/TP / Modbus RTU is to be carried out in accordance with applicable RS485 regulations.
- Modbus / BACnet: Supply and communication are not galvanically isolated. Connect earth signal of the devices with one another.

Wiring diagrams

BACnet MS/TP / Modbus RTU

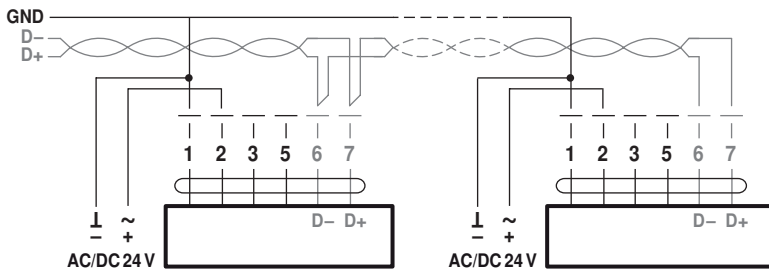

Cable colours:
 1 = black
 2 = red
 3 = white
 5 = orange
 6 = pink
 7 = grey
 Signal assignment Modbus:
 C1 = D- = A
 C2 = D+ = B

Connection with active sensor, e.g. 0...10 V @ 0...50°C

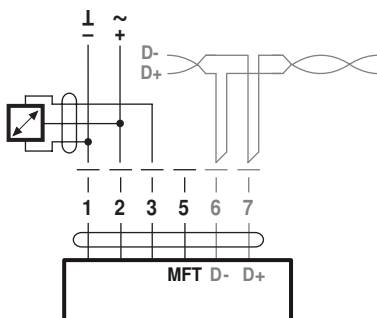

Possible voltage range:
 0...32 V (resolution 30 mV)

Electrical installation

Connection with switching contact, e.g. Δp monitor

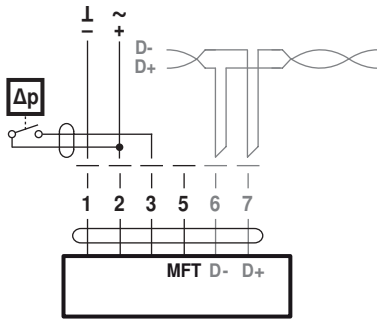

Requirements for switching contact:
The switching contact must be able to accurately switch a current of 16 mA @ 24 V.

Modbus RTU / BACnet MS/TP with analog setpoint (hybrid mode)

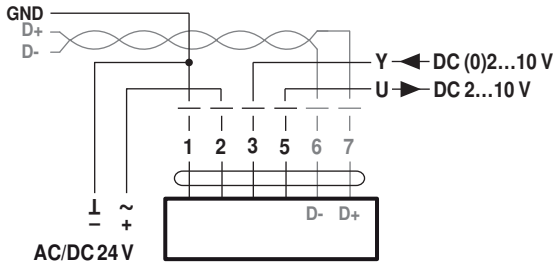

Operation on the MP-Bus

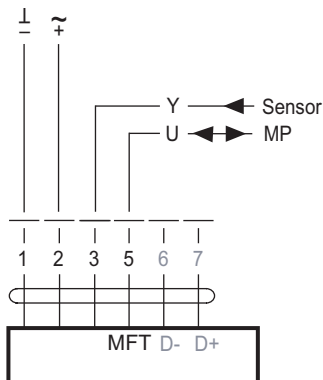

Operating controls and indicators

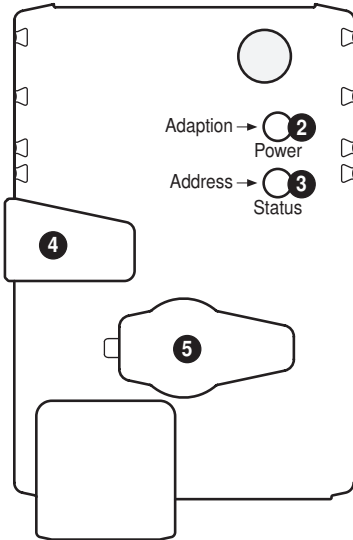

2 Push-button and LED display green

Off: No power supply or malfunction
 On: In operation
 Flashing: In address mode: Pulses according to set address (1...16)
 When starting: Reset to factory setting (Communication)
 Press button: In standard mode: Triggers angle of rotation adaptation
 In address mode: Confirmation of set address (1...16)

3 Push-button and LED display yellow

Off: Standard mode
 On: Adaptation or synchronising process active or actuator in address mode (LED display green flashing)
 Flickering: BACnet / Modbus communication active
 Press button: In operation (>3 s): Switch address mode on and off
 In address mode: Address setting by pressing several times
 When starting (>5 s): Reset to factory setting (Communication)

4 Gear disengagement button

Press button: Gear disengages, motor stops, manual override possible
 Release button: Gear engages, synchronisation starts, followed by standard mode

5 Service plug

For connecting parameterisation and service tools

Check power supply connection

2 Off and 3 On Possible wiring error in power supply

Installation notes

Recommended installation positions

The ball valve can be installed upright to horizontal. The ball valve may not be installed in a hanging position, i.e. with the stem pointing downwards.

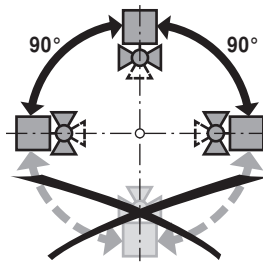

Mounting position in the return

Installation in the return is recommended.

Water quality requirements

The water quality requirements specified in VDI 2035 must be adhered to. Belimo valves are regulating devices. For the valves to function correctly in the long term, they must be kept free from particle debris (e.g. welding beads during installation work). The installation of suitable strainer is recommended.

Maintenance

Ball valves, rotary actuators and sensors are maintenance-free.

Before any service work on the final controlling device is carried out, it is essential to isolate the rotary actuator from the power supply (by unplugging the electrical cable if necessary). Any pumps in the part of the piping system concerned must also be switched off and the appropriate slide valves closed (allow all components to cool down first if necessary and always reduce the system pressure to ambient pressure level).

The system must not be returned to service until the ball valve and the rotary actuator have been correctly reassembled in accordance with the instructions and the pipeline has been refilled by professionally trained personnel.

Flow direction

The direction of flow, specified by an arrow on the housing, is to be complied with, since otherwise the flow rate will be measured incorrectly.

Installation notes

Inlet section In order to achieve the specified measuring accuracy, a flow-calming section or inflow section in the direction of the flow is to be provided upstream from the flow sensor. Its dimensions should be at least 5x DN.

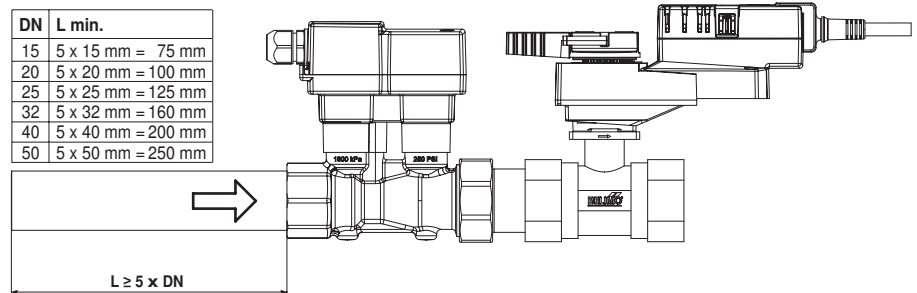

General notes

Valve selection The valve is determined using the maximum required flow rate \dot{V}_{max} . A calculation of the kvs value is not required.
 $\dot{V}_{max} = 30 \dots 100\%$ of \dot{V}_{nom}
 If no hydraulic data are available, then the same valve DN can be selected as the heat exchanger nominal diameter.

Minimum differential pressure (pressure drop) The minimum required differential pressure (pressure drop through the valve) for achieving the desired volumetric flow \dot{V}_{max} can be calculated with the aid of the theoretical kvs value (see type overview) and the below-mentioned formula. The calculated value is dependent on the required maximum volumetric flow \dot{V}_{max} . Higher differential pressures are compensated for automatically by the valve.

Formula

$$\Delta p_{min} = 100 \times \left(\frac{\dot{V}_{max}}{k_{vs \text{ theor.}}} \right)^2$$

Δp_{min} : kPa
\dot{V}_{max} : m ³ /h
$k_{vs \text{ theor.}}$: m ³ /h

Example (DN25 with the desired maximum flow rate = 50% \dot{V}_{nom})
 EP025R+MOD
 $k_{vs \text{ theor.}} = 8.6 \text{ m}^3/\text{h}$
 $\dot{V}_{nom} = 69 \text{ l}/\text{min}$
 $50\% \cdot 69 \text{ l}/\text{min} = 34.5 \text{ l}/\text{min} = 2.07 \text{ m}^3/\text{h}$

$$\Delta p_{min} = 100 \times \left(\frac{\dot{V}_{max}}{k_{vs \text{ theor.}}} \right)^2 = 100 \times \left(\frac{2.07 \text{ m}^3/\text{h}}{8.6 \text{ m}^3/\text{h}} \right)^2 = 6 \text{ kPa}$$

Behaviour with sensor failure In case of a flow sensor error, the EPIV will switch from flow control to position control. Once the error disappears, the EPIV will switch back to the normal control setting.

Service

Quick addressing

1. Press the "Address" button until the green "Power" LED is no longer illuminated. LED flashes in accordance with the previously set address.
2. Set the address by pressing the "Address" button the corresponding number of times (1-16).
3. The green LED flashes in accordance with address that has been entered (1-16). If the address is not correct, then this can be reset in accordance with Step 2.
4. Confirm the address setting by pressing the green "Adaption" button.

If no confirmation occurs for 60 seconds, then the address procedure is ended. Any address change that has already been started will be discarded.
 The resulting BACnet MS/TP and Modbus RTU address is made up of the set basic address plus the short address (e.g. 100+7=107).

Service

Service Tools connection The actuator can be parameterised by ZTH EU via the service socket. For an extended parameterisation the PC tool can be connected.

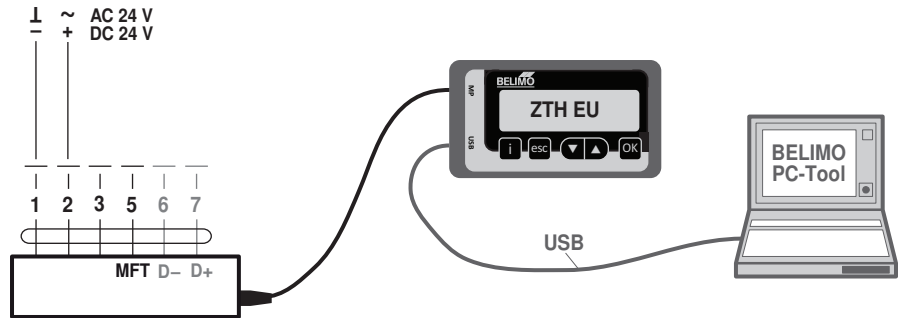

Dimensions / Weight

Dimensional drawings

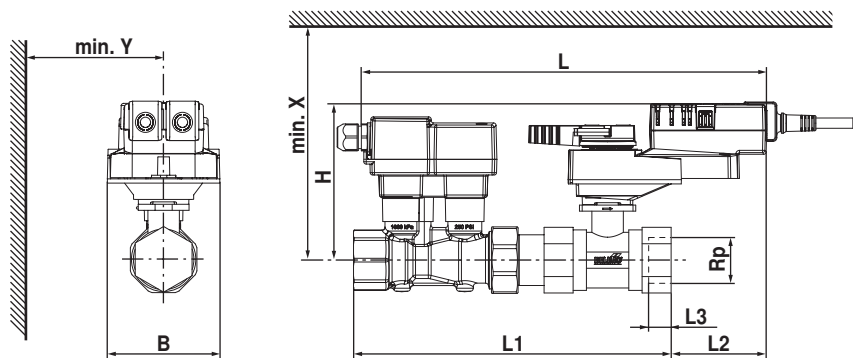

Type	DN []	Rp ["]	L [mm]	L1 [mm]	L2 [mm]	L3 [mm]	B [mm]	H [mm]	X [mm]
EP015R+MOD	15	1/2	275	192	81	13	75	125	195
EP020R+MOD	20	3/4	291	211	75	14	75	125	195
EP025R+MOD	25	1	295	230	71	16	75	127	197
EP032R+MOD	32	1 1/4	323	255	68	19	85	131	201
EP040R+MOD	40	1 1/2	325	267	65	19	85	141	211
EP050R+MOD	50	2	343	288	69	22	95	142	212

Type	Y [mm]	Weight [kg]
EP015R+MOD	77	1.5
EP020R+MOD	77	1.8
EP025R+MOD	77	2.0
EP032R+MOD	77	2.8
EP040R+MOD	77	3.3
EP050R+MOD	77	4.4

Further documentation

- Tool connections
- Description Protocol Implementation Conformance Statement PICS
- Description Modbus register
- Overview MP Cooperation Partners
- MP Glossary
- Introduction to MP-Bus Technology
- General notes for project planning