



## Burner controls

## LME7...

The LME7... is a microprocessor-based burner control with matching system components for the control and supervision of forced draft burners of medium to high capacity.

The LME7... and this Data Sheet are intended for use by OEMs which integrate the burner controls in their products.

### Use

LME7... are used for the startup and supervision of multistage or modulating forced draft burners and atmospheric gas burners in intermittent operation

The fuel-air ratio can be set either via an air damper actuator - acting on mechanical or pneumatic ratio control - or via pulse width modulated fans and pneumatic ratio control.

The flame supervision supervised with ionization probe, with UV flame detector QRA2..., QRA4.U, QRA10..., with photocell detector QRB... or blue flame detector QRC...

- Gas burner controls to EN298: 2003
- Oil burner controls to EN230: 2005
- For gas forced draft burners to EN676
- For oil burners with fan to EN267

### Features

- Burner control
- BCI for connection a display or PC
- Lockout reset button (info button)
- 3 multi color signal lamp LED for operations and fault notifications
- Optional: Analog inputs for load controller DC 0...10 V, DC 0/4...20 mA, 0...135 Ω
- Connection for program module PME...
- Unit parameter adjustable either via display or PC software ACS410
- Optional: 3 x 7 segment display for fault and state information's and parameter display

**Caution!**

All safety, warning and technical notes given in the Basic Documentation of the LME7... (P7105) also apply to this document!

**Standards and certificates**

Conformity to EEC directives  
 - Electromagnetic compatibility EMC (immunity)  
 - Directives for gas-fired appliances  
 - Low-voltage directive

2004/108/EC  
 90/396/EEC  
 2006/95/EC



ISO 9001: 2010  
 Zert. 00739



ISO 14001: 2010  
 Zert. 38233

**Identification code to EN 298 chapter 4**

- PME71.401...: F M C L J N
- PME71.402...: F B C L J N
- PME71.901...: F M C L G N
- PME72.521...: F M L L X N
- PME72.541...: F B L L X N
- PME73.810...: F M C L J N
- PME73.820...: F M C L J N
- PME73.830...: F B C L J N
- PME73.840...: F B C L J N

**Life cycle**

Burner controls LME7... has a designed lifetime\* of 250,000 burner startup cycles which, under normal operating conditions in heating mode, correspond to approx. 10 years of usage (starting from the production date given on the type field). This lifetime is based on the endurance tests specified in standard EN230 / EN298 and the table containing the relevant test documentation as published by the European Association of Component Manufacturers (Afecon) ([www.afecor.org](http://www.afecor.org)).

The designed lifetime is based on use of the burner controls according to the manufacturer's Data Sheet and Basic Documentation. After reaching the designed lifetime in terms of the number of burner startup cycles, or the respective time of usage, the burner control is to be replaced by authorized personnel.

\* The designed lifetime is not the warranty time specified in the Terms of Delivery

**Supplementary documentation**

Environmental Product Declaration LME...	E7105
Basic Documentation LME7...	P7105
Product Overview LME...	Q7101

## System overview

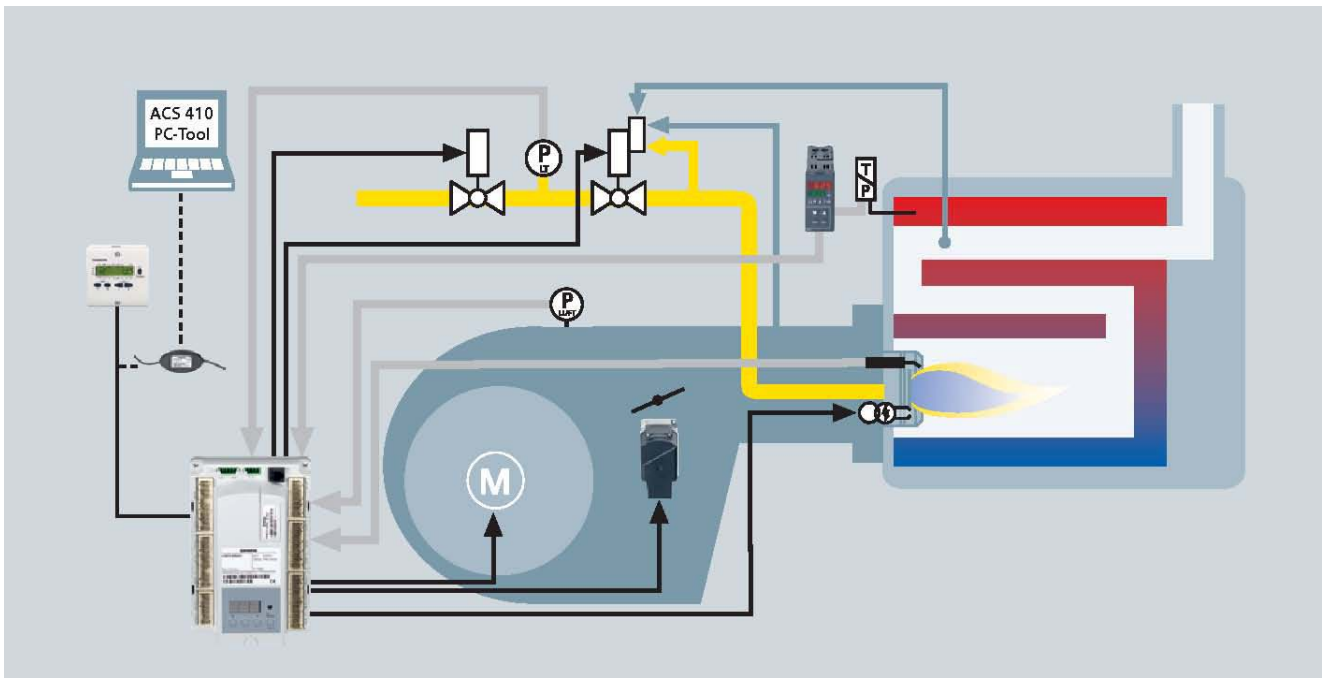

The diagram shows the full scope of functions of the LME7... system. The correct functions are to be determined based on the respective execution / configuration.

## Ordering

### Burner controls

#### LME7...

Parameterized burner controls for the supervision of multi-stage or modulating oil gas / forced draft burners and atmospheric burners of medium to higher capacity, in intermittent operation. With controlled air damper control. Refer to Basic Documentation P7105



Type reference	LME71.000A1	LME71.000A2	LME72.000A2	LME73.000A1	LME73.000A2
Mains voltage AC 120 V	X	---	---	X	---
Mains voltage AC 230 V	---	X	X	---	X
Pressure switch-min-gas / POC	X	X	X	X	X
Pressure switch valve proving	X	X	X	X	X
Air pressure switch	X	X	X	X	X
QRB... / QRC... / ionization probe	X	X	X	X	X
QRA2... / QRA4.U / QRA10...	X	X	---	X	X
Load controller analog input signal (0...10 V, 4...20 mA, 0...135 Ω)	X	X	---	X	X
Load controller input 3-position step input / 2-stage	X	X	X	X	X
Output actuator control	---	---	X	X	X
Input feedback for actuator with potentiometer 0...1 kΩ	---	---	---	X	X
Output PWM control	X	X	X	X	X
Internal LED 7-segment display	X	X	---	X	X
BC interface bus for AZL2...	X	X	X	X	X

**Program module**

**PME7...**

Program module for LME7...  
 With program sequences oil or gas burners for LME7...  
 basic unit  
 Refer to Basic Documentation P7105



**PME7... with mains voltage AC 120 V**

Type reference	PME71.401A1	PME71.402A1	PME71.901A1	PME73.810A1	PME73.820A1	PME73.830A1	PME73.840A1
For operation with LME71.000A...	X	X	X	---	---	---	---
For operation with LME72.000A...	---	---	---	---	---	---	---
For operation with LME73.000A...	---	---	---	X	X	X	X
Gas program forced draft burner	X	X	X	X	X	X	X
Gas program atmospheric burner	---	---	---	---	---	---	---
1-stage / 2-stage or 1-stage modulating	X	X	X	X	X	X	X
Pilot burner intermittent / interrupt	---	X	---	---	---	X	X
Modulating via actuator (pneumatically, mechanical gas-air-ratio control	---	---	X	X	X	X	X
Actuator control via analog signal / 3-position step signal for actuator with potentiometer	---	---	---	X	---	X	---
3-position step signal for actuator without potentiometer	---	---	---	---	X	---	X
Control sequence programmable time	X	X	X	X	X	X	X
POC	X	X	---	X	X	X	X
Valve proving	---	---	X	X	X	X	X

**PME7... with mains voltage AC 230 V**

Type reference	PME71.401A2	PME71.402A2	PME71.901A2	PME72.521A2	PME72.541A2	PME73.810A2	PME73.820A2	PME73.830A2	PME73.840A2
For operation with LME71.000A...	X	X	X	---	---	---	---	---	---
For operation with LME72.000A...	---	---	---	X	X	---	---	---	---
For operation with LME73.000A...	---	---	---	---	---	X	X	X	X
Gas program forced draft burner	X	X	X	X	X	X	X	X	X
Gas program atmospheric burner	---	---	---	---	---	---	---	---	---
1-stage / 2-stage or 1-stage modulating	X	X	X	X	X	X	X	X	X
Pilot burner intermittent / interrupt	---	X	---	---	X	---	---	X	X
Modulating via actuator (pneumatically, mechanical gas-air-ratio control	---	---	X	X	X	X	X	X	X
Actuator control via analog signal / 3-position step signal for actuator with potentiometer	---	---	---	---	---	X	---	X	---
3-position step signal for actuator without potentiometer	---	---	---	X	X	---	X	---	X
Control sequence programmable time	X	X	X	---	---	X	X	X	X
POC	X	X	---	X	X	X	X	X	X
Valve proving	---	---	X	---	---	X	X	X	X

**Display and operating units**

**AZL21.00A9**

Display and operating unit, detached, choice of mounting methods, 8-digit LCD, 5 buttons, BCI for LME39... / LME7..., degree of protection IP40.  
Refer to Data Sheet N7542



**AZL23.00A9**

Display and operating unit, detached, choice of mounting methods, 8-digit LCD, 5 buttons, BCI for LME39... / LME7..., degree of protection IP54.  
Refer to Data Sheet N7542



**AGV50.100**

Signal cable for AZL2..., with RJ11 connector, cable length 1 m, pack of 10



**Connector set for LME7...**

**AGG3.710**

Connector set complete  
RAST5 and RAST3,5  
Single packs  
Refer to object list C7105 (74 319 0642 0)

**AGG3.720**

10 standard connector set complete  
RAST5 and RAST3,5  
Packing in bags of 10 pieces each connector type.  
Refer to object list C7105 (74 319 0642 0)

**AGG3.730**

50 standard connector set complete  
RAST5 and RAST3,5  
Packing in bags of 50 pieces each connector type.  
Refer to object list C7105 (74 319 0642 0)

Example: X5-03



**Flame supervision**

**QRA2...**

UV flame detector for the supervision of gas flames and yellow- / blue-burning oil flames and for ignition spark proving. Plastic insulated housing, metalized to prevent static charging caused by the air flow from the fan, lateral illumination.  
Refer to Data Sheet N7712



**QRA4.U**

UV flame detector for the supervision of gas flames and yellow- / blue-burning oil flames and for ignition spark proving, metal housing, frontal illumination.  
Refer to Data Sheet N7711



**QRA10...**

UV flame detector for supervision of gas flames and yellow- / blue-burning oil flames and for ignition spark proving. Die-cast aluminium housing with a 1 in. mounting coupling and connection facility for cooling air.  
Refer to Data Sheet N7712

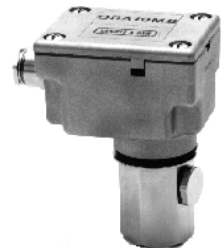

**QRB...**

Photo resistive detector for the supervision of oil flames in the visible light spectrum, plastic housing.  
Refer to Data Sheet N7716



**QRC...**

Blue-flame detector for the supervision of blue- and yellow-burning oil or gas flames, plastic housing.  
Refer to Data Sheet N7714

Frontal illumination:



Lateral illumination:



## Ordering (cont'd)

### Service tools

#### OCI410...

Interface between burner control and PC  
Facilitates viewing, handling and recording setting parameters on site in connection with the ACS410 PC software.  
Refer to Data Sheet N7615



#### ACS410

PC software for setting the parameters and for visualizing the burner controls  
Refer to Software Documentation J7352

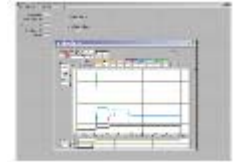

### Actuators

#### SQN3...

Electromotoric actuators for use with air dampers and control valves of oil or gas burners of small to medium capacity.

Holding torque / running time 0,8 Nm / 4,5 s  
up to 3 Nm / 30 s

Refer to Data Sheet N7808



#### SQN7...

Electromotoric actuators for air dampers and control valves of oil and gas burners of small to medium capacity.

Holding torque / running time 0,7 Nm / 4 s  
up to 2,5 Nm / 30 s

Refer to Data Sheet N7804



#### SQM40... / SQM41...

Electromotoric actuators for air dampers and control valves of oil and gas burners of medium to high capacity, with UL-registered.

Holding torque / running time 5 Nm / 15 s  
up to 10 Nm / 30 s

Refer to Data Sheet N7817



#### SQM5...

Electromotoric actuators for air dampers and control valves of oil and gas burners of medium to high capacity, with UL-registered.

Holding torque / running time 10 Nm / 15 s  
up to 40 Nm / 60 s

Refer to Data Sheet N7815



**Accessories**

**KF8895.1A9**

Test case for LME...

- For simulations of burner functions as startups, sequences of operations in connection with the specified burner controls
- For check and test purposes of burner controls
- For operation in laboratories by expert qualified personnel

Refer to User Manual U7993



---

**AGV8895.01**

Connection cable set for LME7..., consisting of:

**AGV8895.01X1**

Connection cable for mains potential



**AGV8895.01X3**

Connection cable for extra-low voltage, PELV



---

**QPLx5...**

The pressure switch is used for monitoring of gas or air pressure.

Refer to Data Sheet N7221



---

**Dummy plug for RJ11**

**Dummy plug**

For 6-pole modulating connector (RJ11)

Supplier recommendation:

Molex, order number: 085 999 3256





Connection diagram LME72...

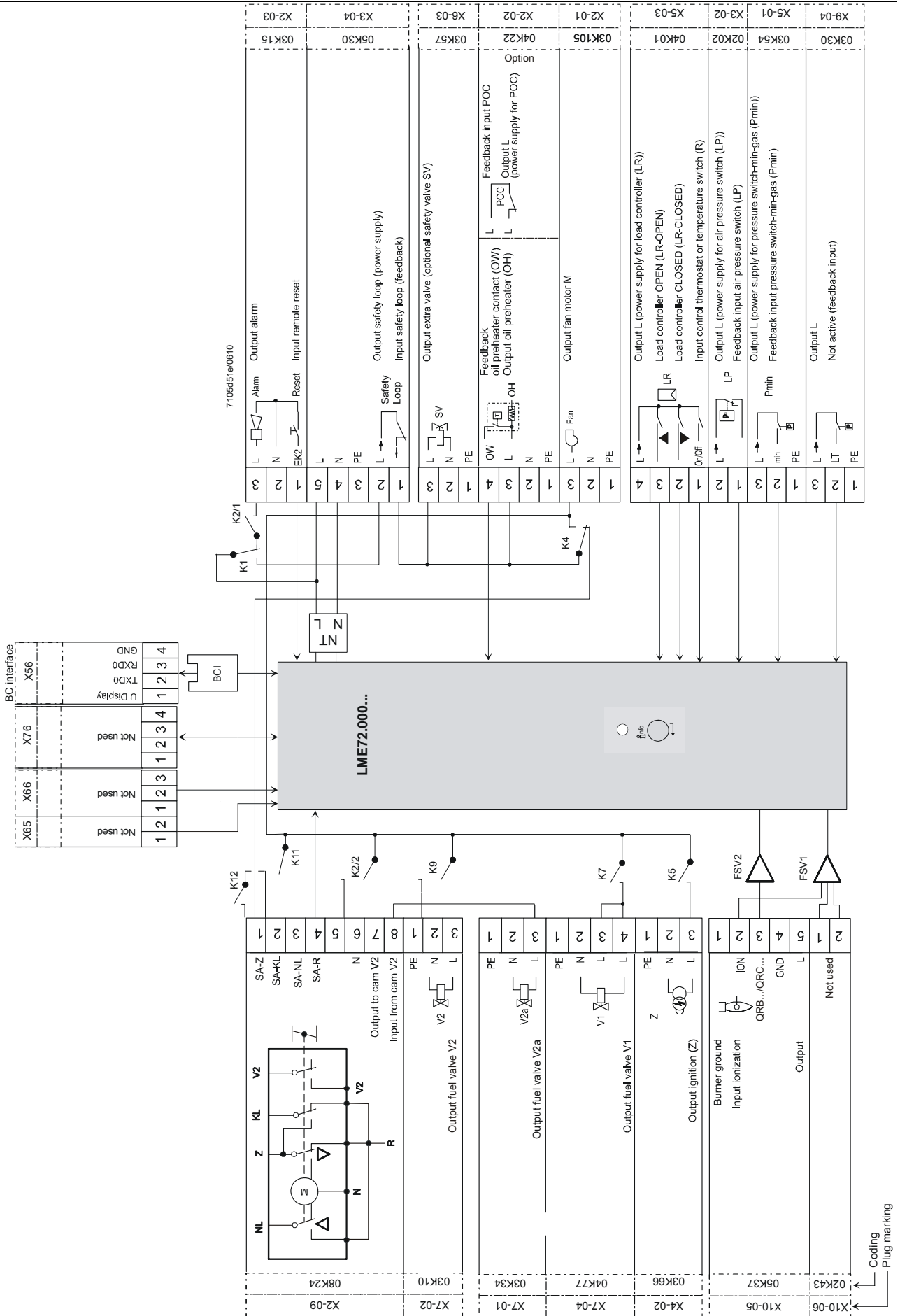

# Connection diagram LME73...

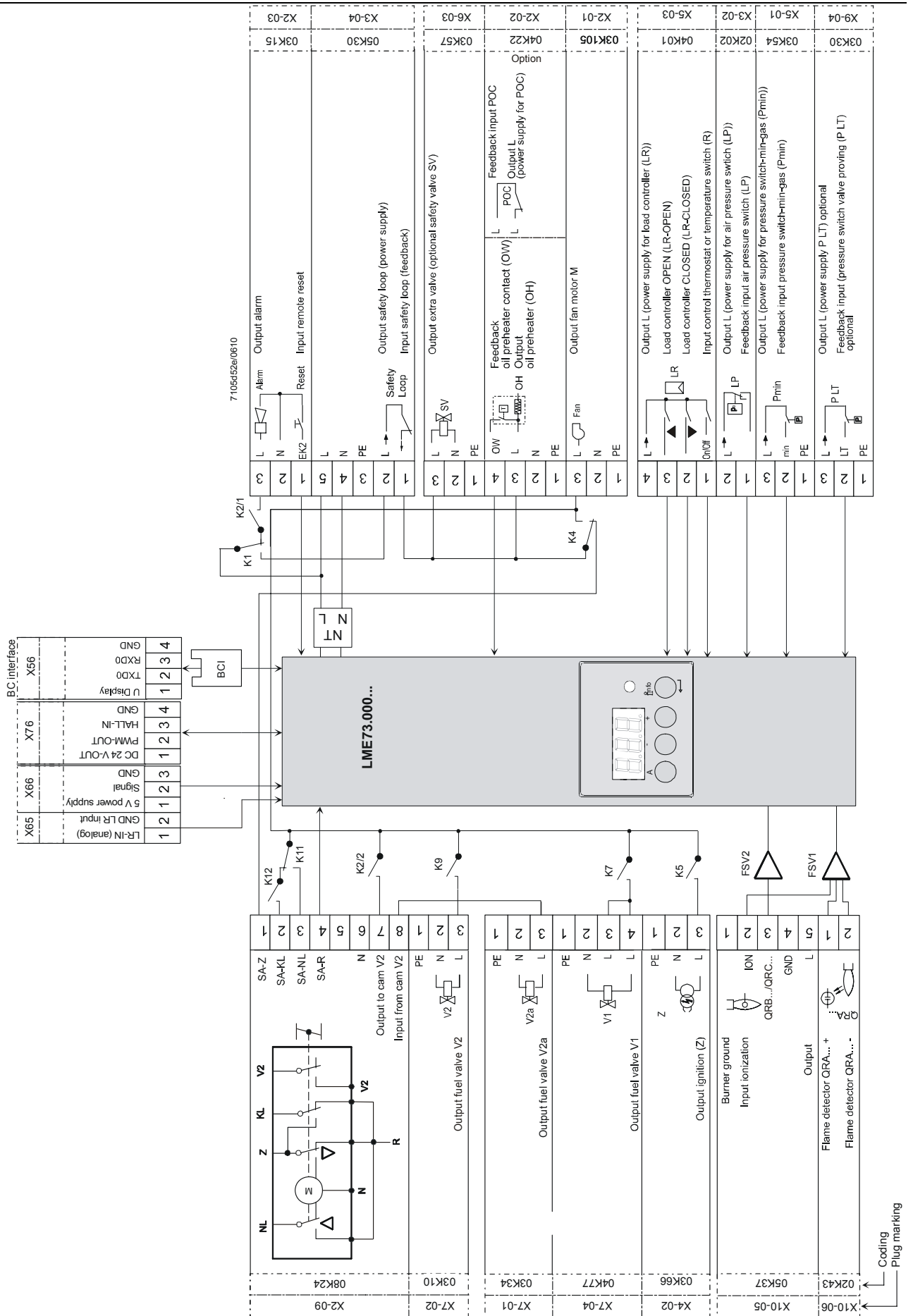

## Technical data

### LME7...

General	Mains voltage (UN)	AC 120 V	AC 230 V
	Mains frequency	50 / 60 Hz ±6 %	50 / 60 Hz ±6 %
	External primary fuse (Si)	Max. 6,3 A, slow	Max. 6,3 A, slow
	Power consumption	<10 W, typical	<10 W, typical
	Safety class	I with parts according to II and III to DIN EN 60730-1	
	Degree of protection	IP00	
	Perm. mounting position	Optional	
	Weight	Approx. 490 g	
	Terminal rating «Inputs»	Under voltage	
• Safety shutdown from the operating position takes place should mains voltage		≤AC 165 V	
• Restart is initiated when mains voltage exceed		≥AC 195 V	
State inputs, control thermostat, temperature switch, load controller, pressure switch, air pressure switch, actuator require mains-related input voltage			
• Input currents and input voltages			
- UeMax		UN +10 %	UN +10 %
- UeMin		UN -15 %	UN -15 %
- IeMax		1,5 mA	1 mA
- IeMin		0,8 mA	0,5 mA
• Transition / settling behavior / bounce			
- Perm. bounce time of contacts when switching ON / OFF	Max. 50 ms	(after the bounce time, the contact must stay closed op open)	
• Logical voltage level			
- ON	>AC 60 V	>AC 120 V	
- OFF	<AC 40 V	<AC 80 V	

## Technical data (cont'd)

### Terminal rating «Outputs»

<b>Total contact loading</b>		
• Rated voltage	AC 120 V	AC 230 V
• Unit input current X3-04 (total input current of all single components)	Max. 5 A	Max. 5 A
<b>Individual contact loading:</b>		
Fan motor X2-01/3		
• Rated current	2 A (15A for max. 0.5s)	2 A (15 A max. 0.5 s)
• Power factor	$\text{Cos}\varphi \geq 0.4$	$\text{Cos}\varphi \geq 0.4$
Alarm output X2-03/3		
• Rated current	1 A	1 A
• Power factor	$\text{Cos}\varphi > 0.6$	$\text{Cos}\varphi > 0.6$
Ignition transformer X4-02/3		
• Rated current	2 A	2 A
• Power factor	$\text{Cos}\varphi > 0.4$	$\text{Cos}\varphi > 0.4$
Output K2/2 X2-09/7		
• Rated current	1 A	1 A
• Power factor	$\text{Cos}\varphi > 0.4$	$\text{Cos}\varphi > 0.4$
Fuel valve / pilot valve (PV) X7-01/3		
• Rated current	1 A	1 A
• Power factor	$\text{Cos}\varphi > 0.4$	$\text{Cos}\varphi > 0.4$
Fuel valve 1 (V1) X7-04/4 / fuel valve 2 (V2) X7-02/3		
• Rated current		
- Valve proving inactive	2 A	2 A
- Valve proving active	1 A	1 A
• Power factor	$\text{Cos}\varphi > 0.4$	$\text{Cos}\varphi > 0.4$
Safety valve (SV) X6-03/3		
• Total current	1.5 A	1.5 A
• Power factor	$\text{Cos}\varphi > 0.6$	$\text{Cos}\varphi > 0.6$
Safety loop (SL) X3-04/2, safety valve (SV) X6-03/3, POC X2-02/3		
• Total current	2 A	2 A
• Power factor	$\text{Cos}\varphi > 0.4$	$\text{Cos}\varphi > 0.4$

### Actuators

<b>Closed / ignition position / open X2-09/1, X2-09/2, X2-09/3</b>		
Rated current	0.1 A (at 1 mio. switching cycles)	
Power factor	$\text{Cos}\varphi > 0.6$	
<b>Output K2/2 X2-09/7</b>		
Rated current	AC 230 V 50 / 60 Hz Max. 1 A	
Power factor	$\text{Cos}\varphi > 0.4$	
Feedback via input of cam V2, depending on the switching contact used in actuator X2-09/8!		

### Cable lengths

• Mains supply line	Max. 100 m (100 pF/m)
• Display, BC interface	Max. 1 m (100 pF/m) (for use under the burner hood or in control panel)
• Load controller (LR)	Max. 30 m (100 pF/m)
• Remote reset (lay separate cable)	Max. 30 m (100 pF/m)
• Fuel valves	Max. 30 m (100 pF/m)
• Other lines	Max. 30 m (100 pF/m)

### Cross-sectional areas

The cross-sectional areas of the mains power lines (L, N, and PE) and the safety loop must be sized for rated currents according to the selected primary fuse. The cross-sectional areas of the other cables must be sized in accordance with the external unit fuse (max. 6.3 AT).

Min. cross-sectional area 0.75 mm<sup>2</sup>

## Technical Data (cont'd)

**Signal cable AGV50...**  
AZL2... → BC interface

<b>Signal cable</b>	Color white Unshielded Conductor 4 x 0.141 mm <sup>2</sup> With RJ11 connector
Cable length AGV50.100	1 m
Supplier (alternative)	Recommendation: Hütter <a href="http://www.huetter.co.at/telefonkabel.htm">http://www.huetter.co.at/telefonkabel.htm</a>
Location	Under the burner hood (arrangements for SKII EN 60730-1 additional required)

## Environmental conditions

<b>Storage</b>	DIN EN 60721-3-1
Climatic conditions	Class 1K3
Mechanical conditions	Class 1M2
Temperature range	-40...+70 °C
Humidity	<95 % r.h.
<b>Transport</b>	DIN EN 60721-3-2
Climatic conditions	Class 2K3
Mechanical conditions	Class 2M2
Temperature range	-40...+70 °C
Humidity	<95 % r.h.
<b>Operation</b>	DIN EN 60721-3-3
Climatic conditions	Class 3K3
Mechanical conditions	Class 3M2
Temperature range	-40...+60 °C
Humidity	<95 % r.h.



**Caution!**  
Condensation, formation of ice and ingress of water are not permitted!

Technical Data (cont'd)

Flame supervision with ionization probe

No-load voltage at terminal ionization probe (ION) (X10-05 terminal 2)	AC 300 V
--	----------



**Caution!**

**The ionization probe must be protected against electric shock hazard (risk of electric shock hazard)!**

Short-circuit current	Max. AC 1 mA
Required detector current	Min. DC 1 $\mu$ A, display approx. 20 %
Possible detector current	Max. DC 40 $\mu$ A, display approx. 100%
Permissible length of detector cable (laid separately)	30 m (core-earth 100 pF/m)

Measuring circuit for detector current measurement

Ionization probe

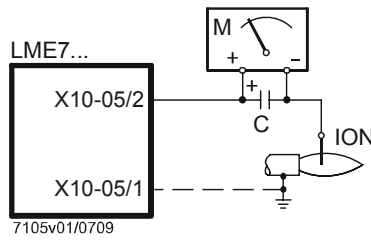

7105v01/0709

Fig. 1: Measuring circuit for ionization probe

Legend

- C Electrolytic condenser 100...470  $\mu$ F; DC 10...25 V
- ION Ionization probe
- M Microammeter  $R_i$  max. 5,000  $\Omega$



**Caution!**

**Simultaneous operation of QRA... and ionization probe is not permitted!**

## Technical Data (cont'd)

### Flame supervision with QRA2... / QRA4.U / QRA10...

Operation voltage	AC 280 V $\pm$ 15 %
Required detector current - In operation	Min. 70 $\mu$ A
Possible detector current - In operation	Max. 700 $\mu$ A
Perm. length of detector cable - Normal cable, laid separately	Max. 100 m

Measuring circuit for detector current measurement

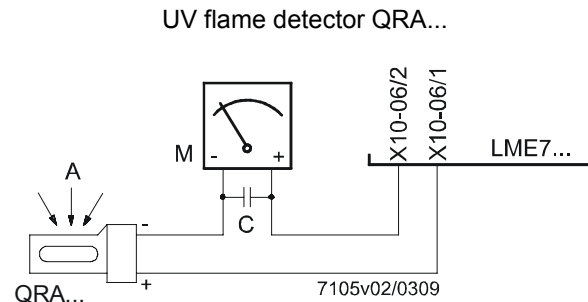

Fig. 2: Measuring circuit for QRA...

#### Legend

- A Exposure to light
- C Electrolytic condenser 100...470  $\mu$ F; DC 10...25 V
- M Microammeter  $R_i$  max. 5,000  $\Omega$



#### Caution!

- Input QRA... is not short-circuit-proof!
- Short-circuit X10-06/2 against earth can destroy the QRA... input
- Simultaneous operation of QRA... and ionization probe is not permitted

### Flame supervision with QRB...

No-load voltage at terminal QRB... (X10-05 terminal 3)	Approx. DC 5 V
Permissible length of QRB... detector cable (laid separately)	3 m (core-core 100 pF/m)

#### Threshold values QRB... flame supervision with LME7...

Prevention of startup (extraneous light) with RQRB	Approx. 400 k $\Omega$ , display ca. 14 %
Operation with RQRB	Approx. 230 k $\Omega$ , display ca. 34 %
Short-circuit detection with RQRB	<0.5 k $\Omega$

A flame detector resistance of  $R_F < 500 \Omega$  is identified as a short-circuit and leads to safety shutdown in operation, like in the case of loss of flame.



**Technical Data (cont'd)**

**Flame supervision with QRC...**

Required detector current (with flame)	Min. 70 $\mu$ A
Possible detector current (without flame)	Max. 5,5 $\mu$ A
Perm. detector current with flame (typical)	Max. 100 $\mu$ A

The values given in the table above only apply under the following conditions:  
 - Mains voltage AC 120 V / AC 230 V  
 - Ambient temperature 23 °C

Prevention of startup (extraneous light) with IQRC	Approx. 10 $\mu$ A, display ca. 14 %
Operation with IQRC	Approx. 20 $\mu$ A, display ca. 34 %

**Measuring circuit for detector current measurement**

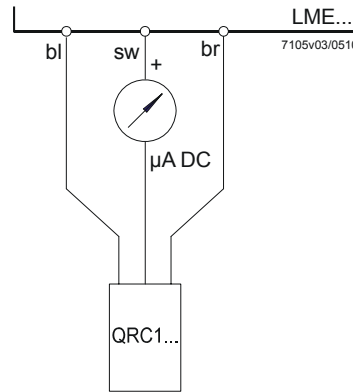

**Legend**

- $\mu$ A DC DC microammeter with an internal resistance of  $R_i = \text{max. } 5k\Omega$
- bl Blue
- sw Black
- br Brown

As an alternative to detector current measurement, the OCI410 / ACS410 diagnostics tool can be used. In that case, the DC microammeter is not required.

# Dimensions

Dimensions in mm

LME7...

