

**LOW NO<sub>x</sub> DUAL FUEL BURNERS**

▶ **RLS/BP MX SERIES**

▶ **RLS 300/BP MX** 600/1250 + 3650 kW

▶ **RLS 400/BP MX** 1000/2000 + 4500 kW



RLS/BP MX series burners are characterised by a modular monoblock structure that means all necessary components can be combined in a single unit thus making installation easier, faster and, above all, more flexible.

The series covers a firing range from 600 to 4500 kW, and they have been designed for use in hot water boilers, overheated water boilers as well as steamboilers. Burners working is 2 stages on the oil side and two stages progressive on the gas side. Alternatively the gas working can be modulating with the installation of a PID logic regulator. Using a particular proportioning gas valve the burner keeps the desired air/gas ratio in every working condition. The innovative combustion head which is able to reach good performances in term of Low NO<sub>x</sub> either during gas working or light oil working and reducing noise.



# TECHNICAL DATA

Model			▼ RLS 300/BP MX	▼ RLS 400/BP MX
Burner operation mode			two stages light oil - two stages progressive/modulating gas	
Modulation ratio at max. output			1 + 3 (light oil) / 1 + 4 (gas)	
Servomotor	run time	type	SQM 10	
		s		
Heat output		kW	600/1250 ÷ 3650	1000/2000 ÷ 4500
		Mcal/h	516/1075-3139	860/1720-3870
Working temperature			°C min./max. 0/60	
Light Oil	net calorific value	kWh/kg	11,86	
	density	kg/l	0,82	
	viscosity at 20°C	mm <sup>2</sup> /s (cSt)	4-6	
	delivery	kg/h	50/105-308	84/169-380
Pump		type	TA2	
	delivery	kg/h	340 (20 bar)	
Atomised pressure			bar 12	
Fuel temperature			max. °C 50	
Fuel pre-heater			NO	
G20	net calorific value	kWh/Nm <sup>3</sup>	10	
	density	kg/Nm <sup>3</sup>	0,71	
	gas delivery	Nm <sup>3</sup> /h	60/125-365	100/200-450
G25	net calorific value	kWh/Nm <sup>3</sup>	8,6	
	density	kg/Nm <sup>3</sup>	0,78	
	gas delivery	Nm <sup>3</sup> /h	70/145-424	116/232-523
LPG	net calorific value	kWh/Nm <sup>3</sup>	--	
	density	kg/Nm <sup>3</sup>	--	
	gas delivery	Nm <sup>3</sup> /h	--	
Fan			type reverse blade fan wheels	
Air temperature			max °C 60	
Electrical supply			Ph/Hz/V 3/50/230-400 (±10%)	3/50/400 (±10%)
Auxiliary electrical supply			Ph/Hz/V 1/50/430 (±10%)	
Control box			type LFL 1.333	
Total electrical power			kW 6	9
Auxiliary electrical power			kW 1,5	1,5
Heaters electrical power			kW --	
Protection level			IP 54	
Pump motor electrical power			kW 1,1	
Rated pump motor current			A 3,7	
Pump motor start up current			A 24	
Pump motor protection level			IP 55	
Fan motor electrical power			kW 4,5	7,5
Rated fan motor current			A 9,1-15,8	17,5 - 30
Fan motor start up current			A 51-86	113 - 195
Fan motor protection level			IP 55	
Ignition transformer			type N.A.	
			V1 - V2 230 V - 2 x 5 kW	
			I1 - I2 1,9 A - 35 mA	
Working			intermittent (1 stop each 24 h)	
Sound pressure			dB (A) 83	85
Sound power			W N.A.	
Light Oil	CO emission	mg/kWh	< 10	
	grade of smoke indicator	N° Bacharach	< 2	
	CxHy emission	mg/kWh	< 2	
	NOx emission	mg/kWh	< 185	
G20	CO emission	mg/kWh	< 10	
	NOx emission	mg/kWh	< 80	
Directive			90/396 - 89/336 - 73/23 EEC	
Conforming to			EN 267 - EN 676	
Certification			CE in progress	

Reference conditions: Temperature: 20°C - Pressure: 1000 mbar - Altitude: 100 m a.s.l. - Noise measured at a distance of 1 meter.

Since the Company is constantly engaged in the production improvement, the aesthetic and dimensional features, the technical data, the equipment and the accessories can be changed.  
This document contains confidential and proprietary information of RIELLO S.p.A. Unless authorised, this information shall not be divulged, nor duplicated in whole or in part.



# FIRING RATES

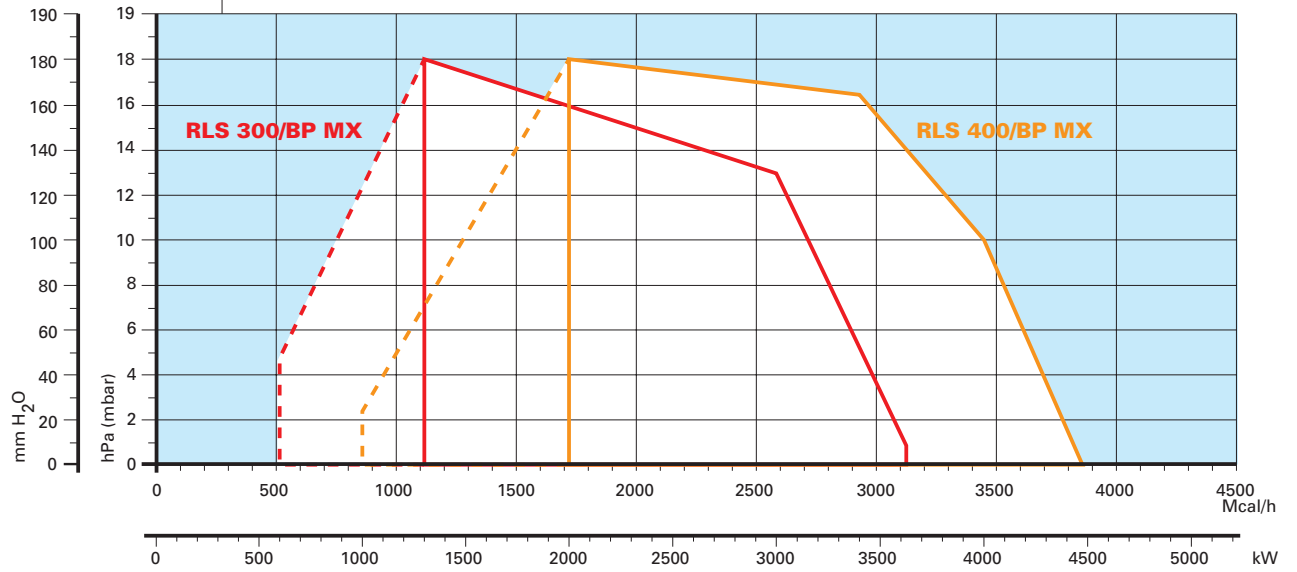

Useful working field for choosing the burner

Modulation range

**Test conditions conforming to EN 676:**

Temperature: 20°C  
Pressure: 1000 mbar  
Altitude: 100 m a.s.l.





## FUEL SUPPLY

### GAS TRAIN

The gas train can be selected to best fit system requirements depending on the fuel output and pressure in the supply line.

The proportioning valve installed on the gas train maintains constant desired air to gas ratio in every working condition regardless variation of external factors such as: changing in gas pressure, air delivery, chamber backpressure and voltage fluctuation.

This result is obtained by measuring: air pressure after air damper, gas pressure entering the burner and chamber backpressure.

Fuel can be supplied either from the right or left side, on the basis of the application.

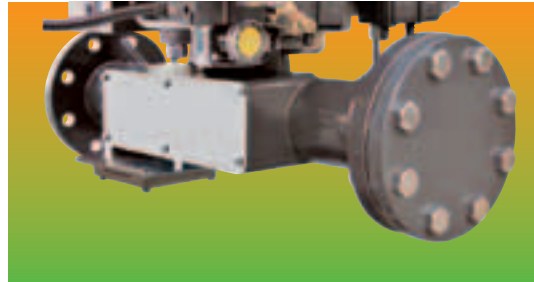

Example of the RLS/BP MX gas inlet.

### VGD gas train with seal control

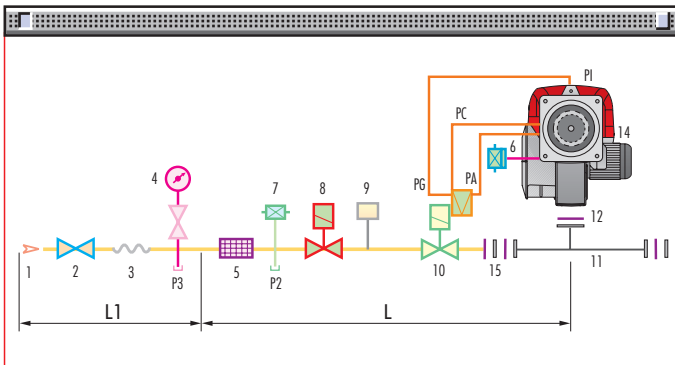

1	Gas input pipework
2	Manual valve
3	Anti-vibration joint
4	Pressure gauge with pushbutton cock
5	Filter
6	Maximum gas pressure switch
7	Minimum pressure switch
8	Safety shut-off valve VS
9	Gas leak detection control device
10	Air/gas ratio control/shut-off valve VR
11	Gas train/burner adaptor
12	Standard issue burner gasket with flange
13	Flange gasket
14	Burner
15	Gas train burner adapter (not present on gas train DN80)
16	Blind flange
P1	Pressure at combustion head
P2	Pressure downstream the filter
P3	Pressure upstream the filter
PA	Air pressure test point
PC	Combustion chamber pressure test point
PG	Gas pressure test point
L	Gas train supplied separately, with code
L1	Installer's responsibility

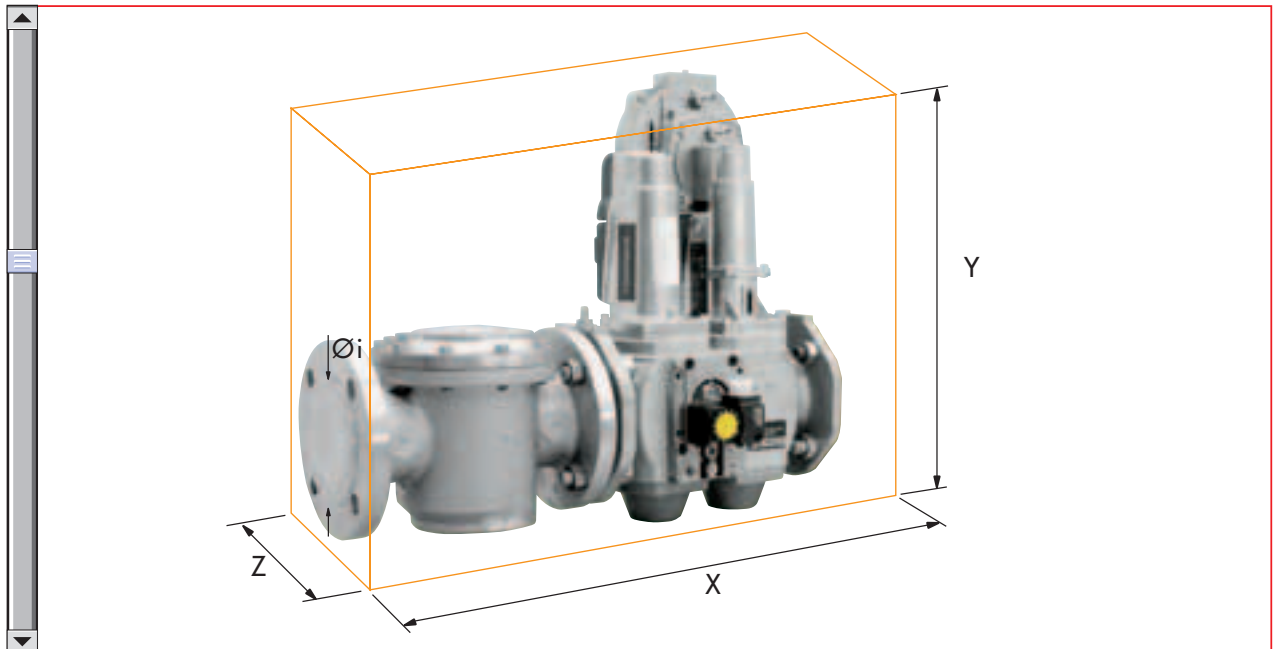

Example of gas train VGDF type

Gas trains are approved by standard EN 676 together with the burner.

The overall dimensions of the gas train depends on how they are constructed. The following table shows the maximum dimensions of the gas trains that can be fitted to RLS/BP MX burners, intake and outlet diameters. Please note that leakage control has to be installed as an accessory.

The maximum working gas pressure is 500 mbar (with leakage control type VPS 504 maximum gas pressure is 500 mbar).

	Name	Code	Ø i	X	Y	Z	Seal Control
<b>GAS TRAINS</b>	<b>VGDF 50</b>	3970215	2"	615	495	245	3010367
	<b>VGDF 65</b>	3970212	DN 65	600	520	245	3010367
	<b>VGDF 80</b>	3970213	DN 80	625	545	245	3010367
	<b>VGDF 100</b>	3970214	DN 100	755	575	245	3010367



## ► PRESSURE DROP DIAGRAM

The diagrams indicate the minimum pressure drop of the burners with the various gas trains that can be matched with them; at the value of these pressure drop add the combustion chamber pressure.

The value thus calculated represents the minimum required input pressure to the gas train related to the needed capacity.

Gas inlet pressure should not exceed 20% of total pressure drop (head, chamber and gas train) in order to keep a wide and stable modulation range.

### NATURAL GAS

#### RLS 300/BP MX

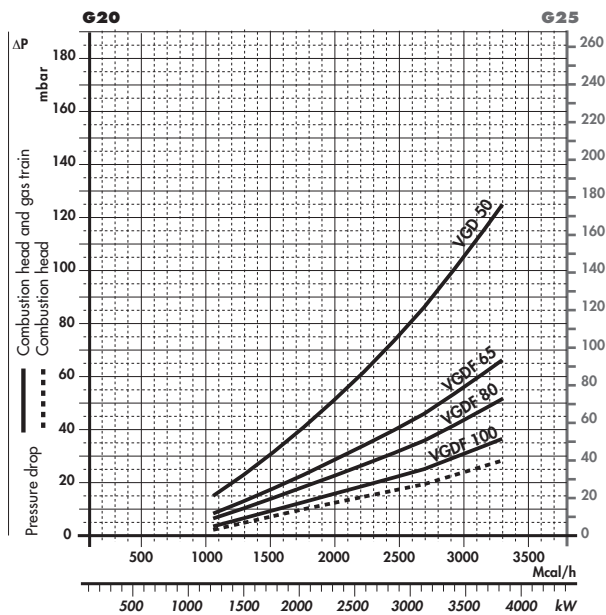

Gas train	Code	Adapter	Seal Control
VGD 50	3970215	3010222	3010367
VGDF 65	3970212	3010222	3010367
VGDF 80	3970213	3010222	3010367
VGDF 100	3970214	3010222	3010367

#### RLS 400/BP MX

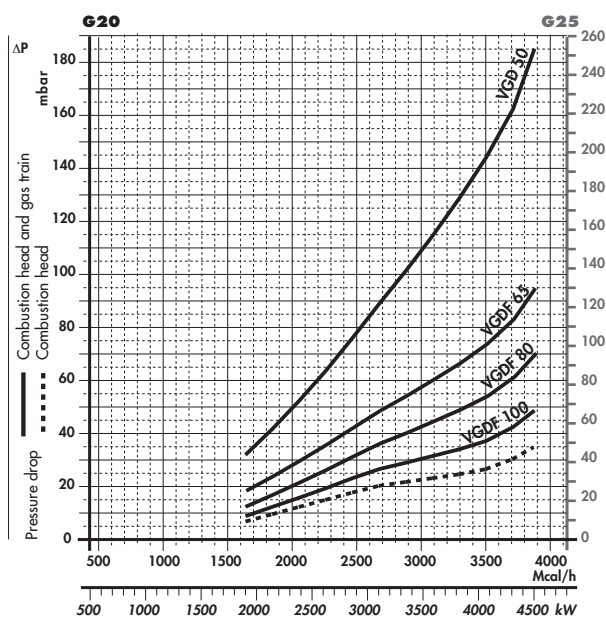

Gas train	Code	Adapter	Seal Control
VGD 50	3970215	3010222	3010367
VGDF 65	3970212	3010222	3010367
VGDF 80	3970213	3010222	3010367
VGDF 100	3970214	3010222	3010367

**note** Please contact the Riello Burner Technical Office for different pressure levels from those above indicated and refer to the technical manual for optimised selection.

## SELECTING THE FUEL SUPPLY LINES

The following diagram enables pressure drop in a pre-existing gas line to be calculated and to select the correct gas train.

The diagram can also be used to select a new gas line when fuel output and pipe length are known. The pipe diameter is selected on the basis of the desired pressure drop. The diagram uses methane gas as reference; if another gas is used, conversion coefficient and a simple formula (on the diagram) transform the gas output to a methane equivalent (refer to figure A). Please note that the gas train dimensions must take into account the back pressure of the combustion chamber during operations.

### Control of the pressure drop in an existing gas line or selecting a new gas supply line.

The methane output equivalent is determined by the formula fig. A on the diagram and the conversion coefficient.

Once the equivalent output has been determined on the delivery scale ( $\dot{V}$ ), shown at the top of the diagram, move vertically downwards until you cross the line that represents the pipe diameter; at this point, move horizontally to the left until you meet the line that represents the pipe length.

Once this point is established you can verify, by moving vertically downwards, the pipe pressure drop of on the bottom scale below (mbar).

By subtracting this value from the pressure measured on the gas meter, the correct pressure value will be found for the choice of gas train.

**Example:**

- gas used	G25
- gas output	9.51 mc/h
- pressure at the gas meter	20 mbar
- gas line length	15 m
- conversion coefficient	0.62 (see figure A)

- equivalent methane output  $\dot{V} = \left[ \frac{9.51}{0.62} \right] = 15.34 \text{ mc/h}$

- once the value of 15.34 has been identified on the output scale ( $\dot{V}$ ), moving vertically downwards you cross the line that represents 1" 1/4 (the chosen diameter for the piping);
- from this point, move horizontally to the left until you meet the line that represents the length of 15 m of the piping;
- move vertically downwards to determine a value of 1.4 mbar in the pressure drop bottom scale;
- subtract the determined pressure drop from the meter pressure, the correct pressure level will be found for the choice of gas train;
- correct pressure = ( 20-1.4 ) = 18.6 mbar

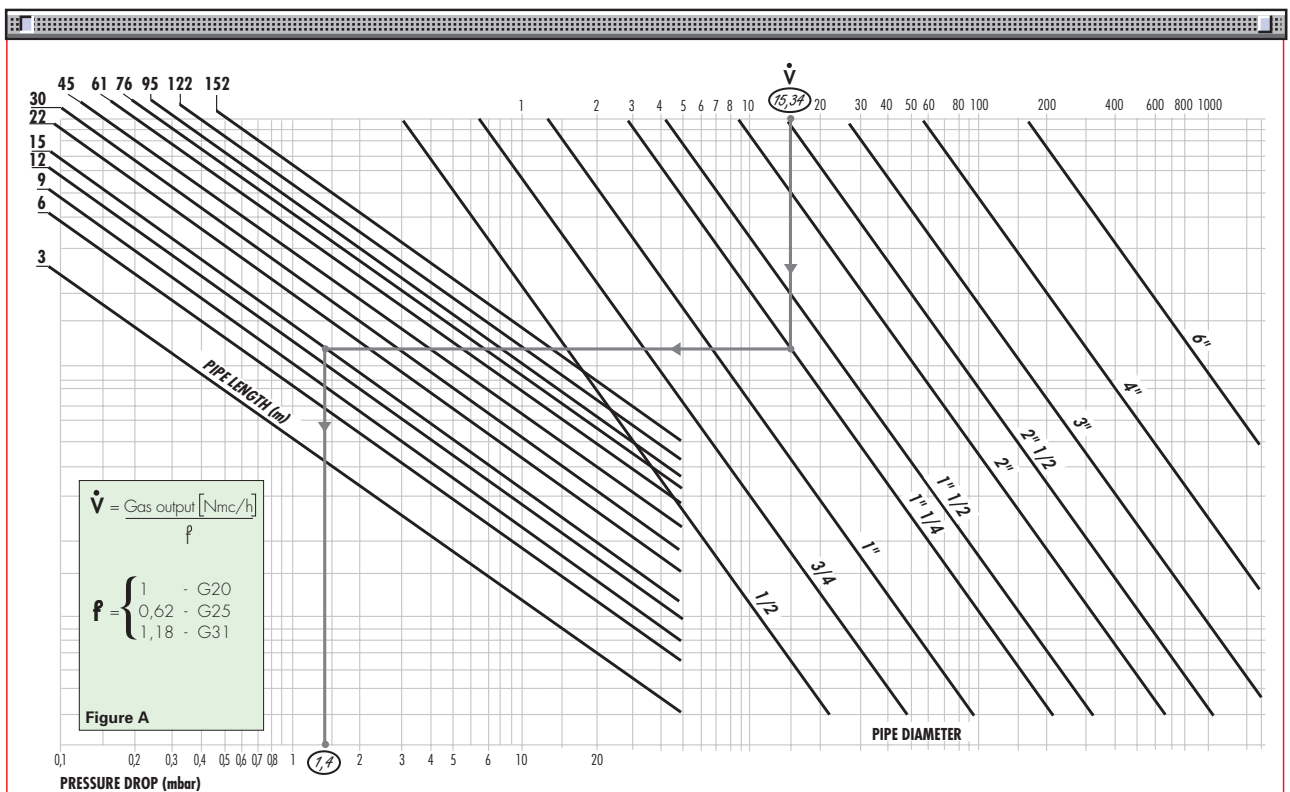

## HYDRAULIC CIRCUIT

The burners are fitted with three valves (a safety valve and two oil delivery valves) along the oil line from the pump to the nozzle.

A thermostatic control device, on the basis of required output, regulates oil delivery valves opening, allowing light oil passage through the valves and to the nozzle. Delivery valves open contemporary to the air damper opening, controlled by a servomotor.

The pumping group is fitted with a pump, an oil filter and a regulating valve: through this it is possible to manually adjust atomised pressure, which in factory is preset at 12 bar.



Example of light oil pump of RLS BP/M MX burner

### RLS BP/MX

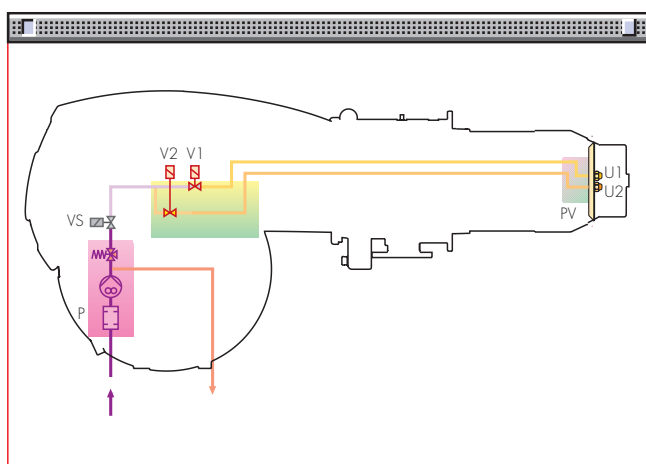

P	Pump with filter and pressure regulator on the output circuit
VS	Safety valve on the output circuit
V1	1st stage valve
V2	2nd stage valve
PV	Nozzle holder
U1	1st stage nozzle
U2	2nd stage nozzle





## ▶ SELECTING THE FUEL SUPPLY LINES

The fuel feed must be completed with the safety devices required by the local norms.

The table shows the choice of piping diameter, depending on the difference in height between the burner and the tank and their distance.

MAXIMUM EQUIVALENT LENGTH FOR THE PIPING L[m]		
Model	▼ RLS 300-400 BP/M MX	
Diameter piping	Ø16mm	Ø18mm
+H, -H (m)	Lmax (m)	Lmax (m)
+4,0	60	80
+3,0	50	70
+2,0	40	60
+1,5	35	55
+1,0	30	50
+0,5	25	45
0	20	40
-0,5	18	35
-1,0	15	30
-1,5	13	25
-2,0	10	20
-3,0	5	10
-4,0	-	6

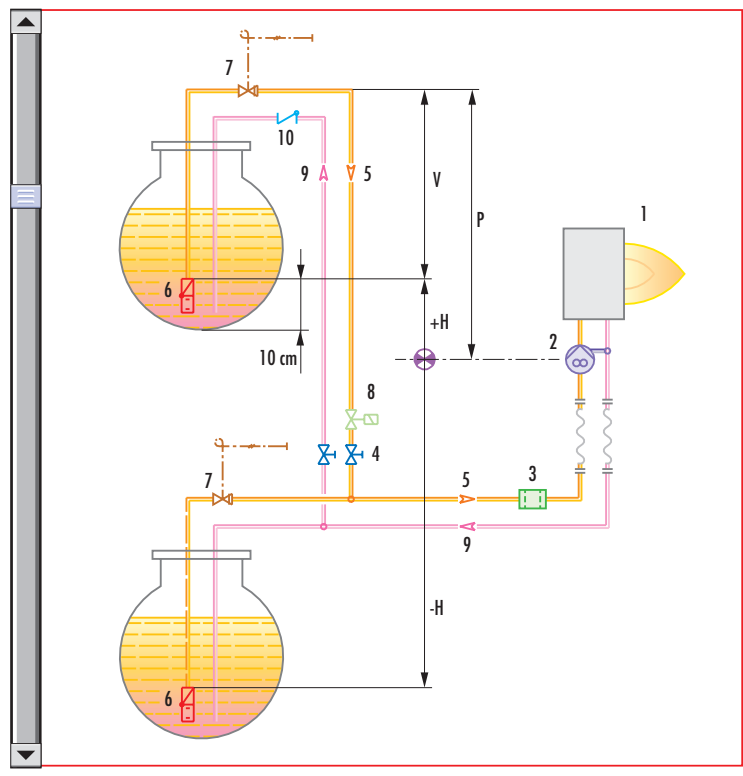

H	Difference in height pump-foot valve
Ø	Internal pipe diameter
P	Max. height 10 m
V	Height 4 m
1	Burner
2	Burner pump
3	Filter
4	Manual shut off valve
5	Suction pipework
6	Bottom valve
7	Remote controlled rapid manual shut off valve (compulsory in Italy)
8	Type approved shut off solenoid valve (compulsory in Italy)
9	Return pipework
10	Check valve

▶ **note** With ring distribution oil systems, the feasible drawings and dimensioning are the responsibility of specialised engineering studios, who must check compatibility with the requirements and features of each single installation.





## VENTILATION

The ventilation unit comes with a sound proofing radial regulating system.

All the burners in the RLS/BP MX series are fitted with fans with

reverse curve blades, which give excellent performance and are fitted in line with the combustion head. The air flow and sound-deadening materials used in the construction are designed to reduce sound emissions to the minimum and guarantee high levels of performance in terms of output and air pressure.

A high precision servomotor through the main management module installed on each burner of RLS/BP MX series, controls the air dampers position constantly.



Example of a sound proofing radial regulating system

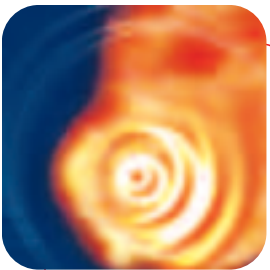

## COMBUSTION HEAD

Different lengths of the combustion head can be chosen for the RLS/BP MX series of burner. The choice depends on the thickness of the

front panel and the type of boiler. Depending on the type of generator, check that the penetration of the head into the combustion chamber is correct.

The head is designed to allow Low NOx emissions.



Example of a RLS BP/MX burner combustion head

### Flame dimensions

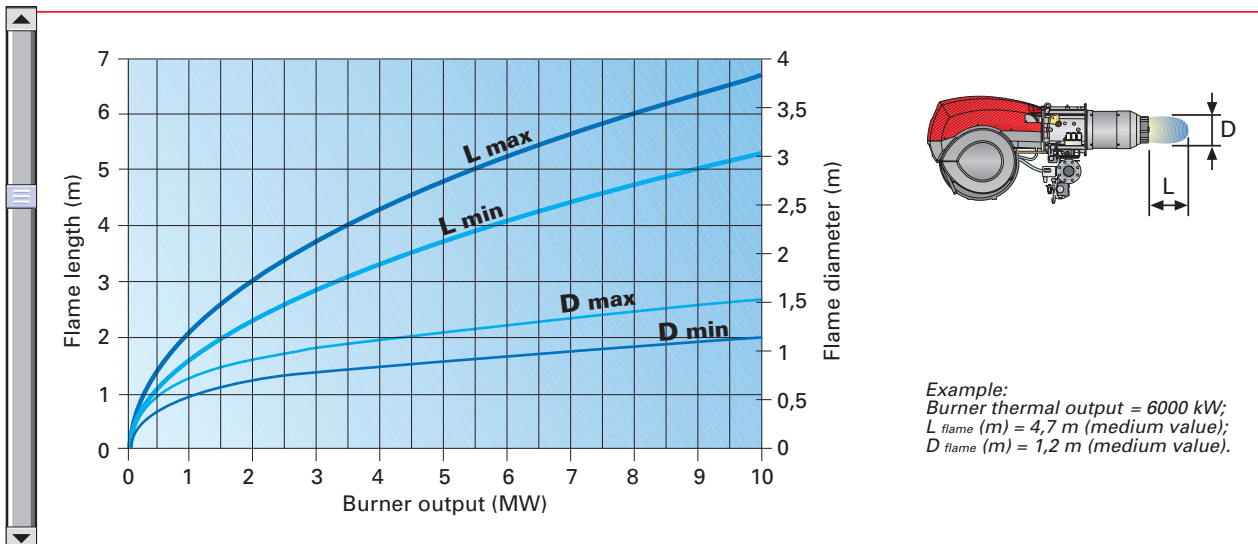

# ADJUSTMENT



## BURNER OPERATION MODE

The RLS/BP MX series of burners can have "two stage" operation at the oil side and "modulating" operation at the gas side with the installation of a PID logic regulator and respective probes. When burner is supplied with light oil a modulation ratio of 3:1 is reached thanks to the "two nozzles" solution; when burner is supplied with gas modulation ratio is 4:1. The air is adapted to the servomotor rotations.

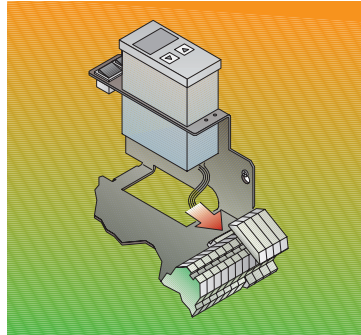

Example of a regulator

On "two stage" operation, the burner gradually adjusts output to the requested level, by varying between the two pre-set levels (see figure A).

### "Two stage" operation

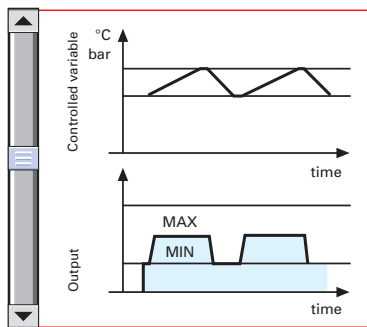

Figure A

In "modulating" operation, normally required in steam generators, in superheater boilers or diathermic oil burners, a specific regulator and probes are required. These are supplied as accessories that must be ordered separately. The burner can work for long periods at intermediate output levels (see figure B).

### "Modulating" operation

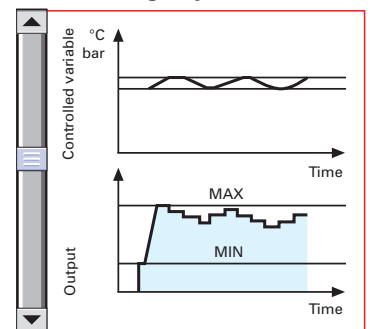

Figure B

## START UP CYCLE

### BURNER STARTING (A)

- 0s Load control TL closes.  
Fan motor starts.
- 6s Servomotor starts: 90° rotation to right, until contact is made on cam 1). The air gate valve is positioned to MAX. output.
- 35s Pre-purge stage with air delivery at MAX. output. Duration 31.5 seconds.
- 66.5s Servomotor rotates to left up to the angle set on cam 3) (between 3 and 10°).
- 94s The air gate valve and the gas butterfly are positioned to MIN. output. (with cam 3).
- 97s Ignition electrode strikes a spark.
- 103s Safety valve YS and adjustment valve YR (rapid stroke) open. The flame is ignited at a low output level (point A). Delivery is then progressively increased, with the valve opening slowly up to MIN output.
- 106s The spark goes out.
- 127s The control box starting cycle ends.

### RLS/BP MX

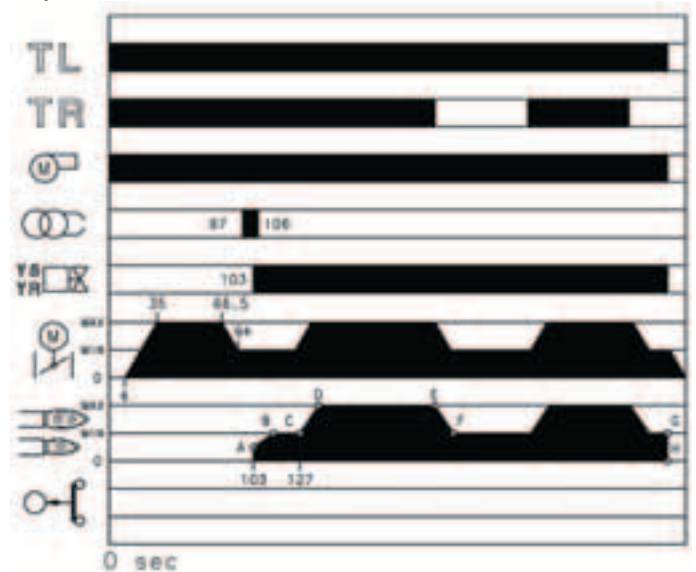



# WIRING DIAGRAMS

Electrical connections must be made by qualified and skilled personnel, according to the local norms.

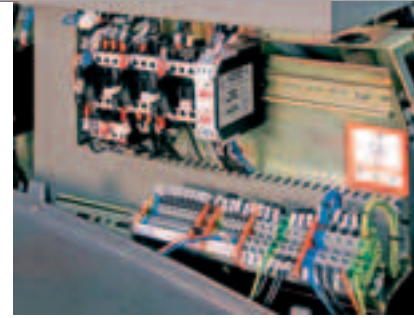

Example of the terminal board for electrical connections

## THREE PHASE SUPPLY TO THE POWER CIRCUIT AND CONNECTING THE AUXILIARY CONTROLS

### RLS 300/BP MX

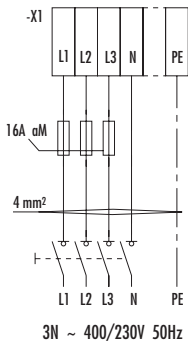

### RLS 400//BP MX

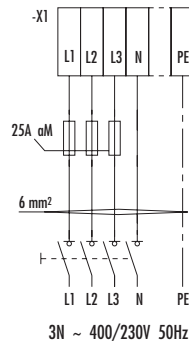

### Triggering / Safety devices

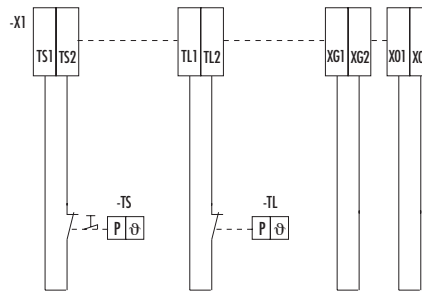

**X1** - General supply terminal board  
**TS** - Safety thermostat  
**TL** - Threshold thermostat

## CONNECTION OF THE PROBES FOR THE CONTROLLED PARAMETER AND DATA CONNECTION FOR THE VARIOUS MODULES (Accessories)

### Gas valve + PVP leak detection

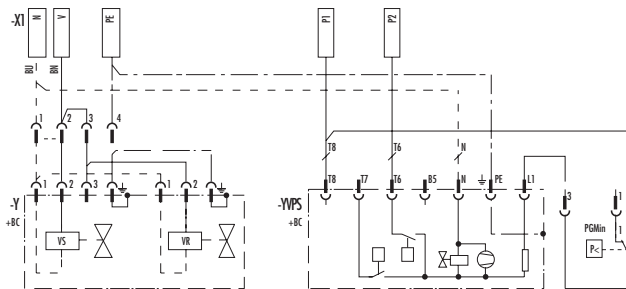

### Power regulation with 3-position contact

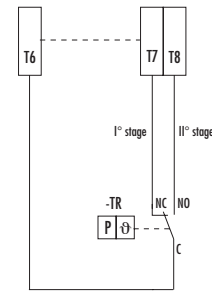

**TR** - High/Low flame setting thermostat  
**YVPS** - Seal control  
**VS** - Safety valve  
**VR** - Adjustment valve  
**BT4** - Temperature probe  
**BP** - Pressure probe

### RWF40

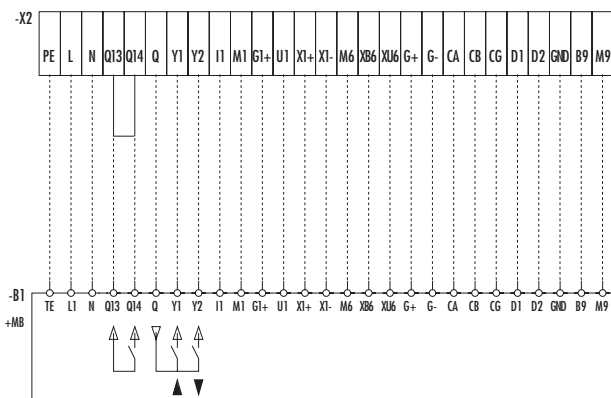

### Possibility of modulation input with Riello probe

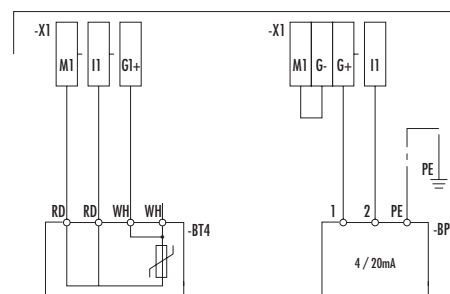



## OPTIONAL CONNECTION

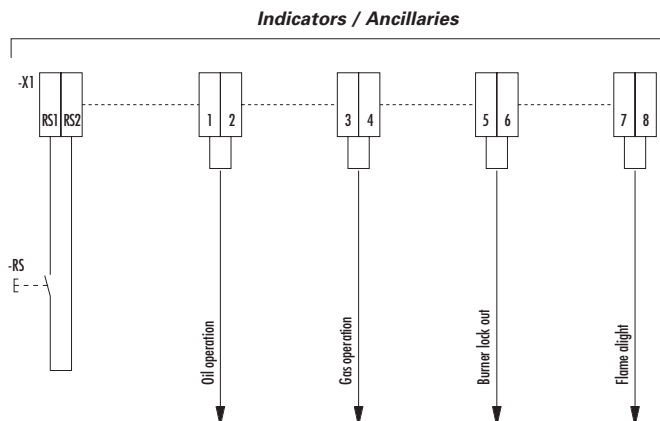

## OPTIONAL CONNECTION POWER REGULATOR

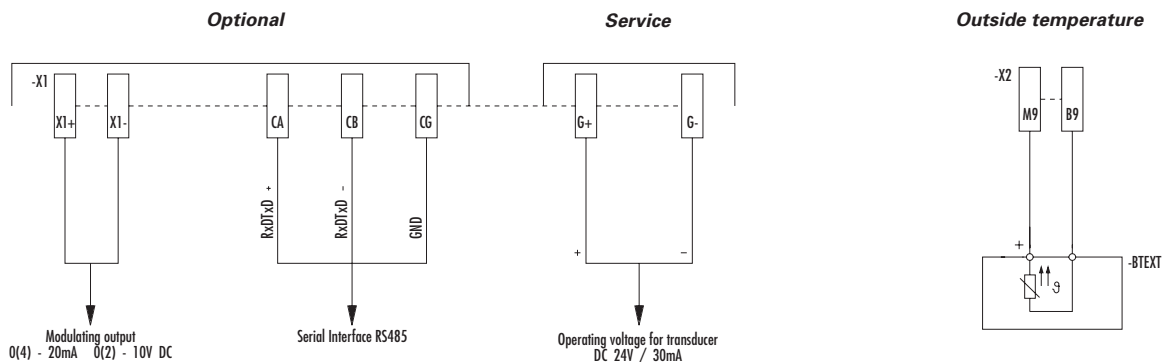

### Possibility of setpoint input and setpoint shift

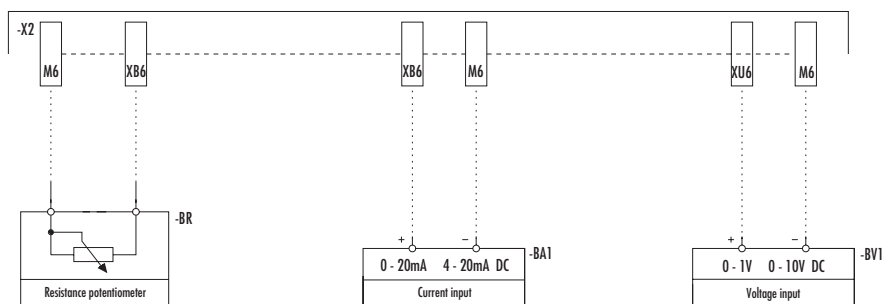

- BTEXT** - Outside temperature
- BV1** - Voltage input
- BA1** - Current input
- BR** - Resistance potentiometer

### Possibility of modulation input

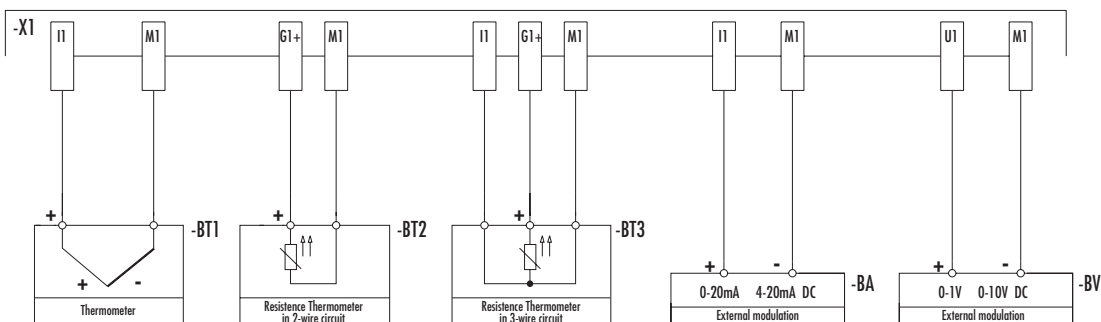



### Possibility of modulation input with Riello Probe

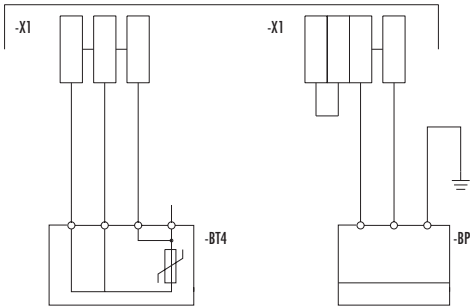

### Modulation input with QBE620-P...

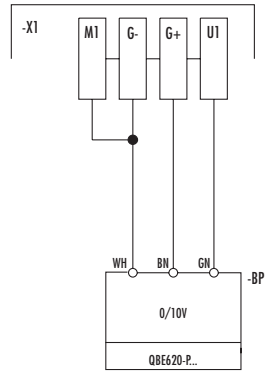

### Fuel remote selector

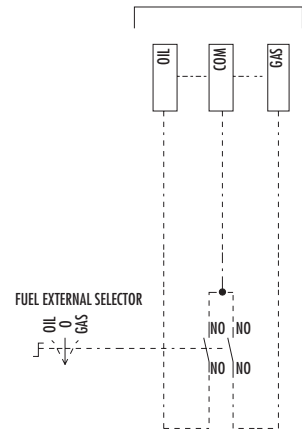

Only with remote external fuel kit

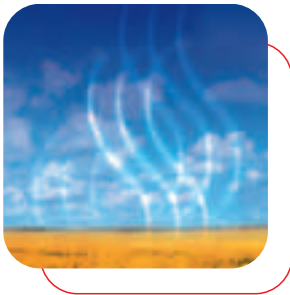

## EMISSIONS

- Gas working
- Light oil working

The emission data has been measured in the various models at maximum output, according to EN 676 and EN 267 standard.

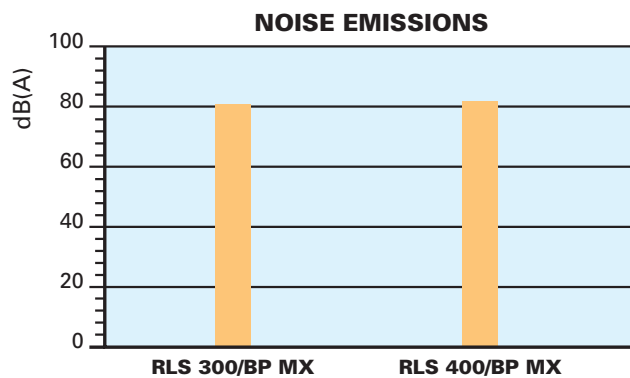
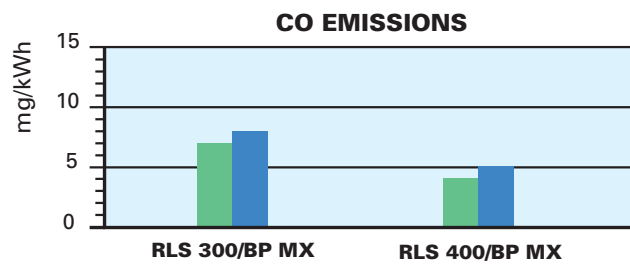
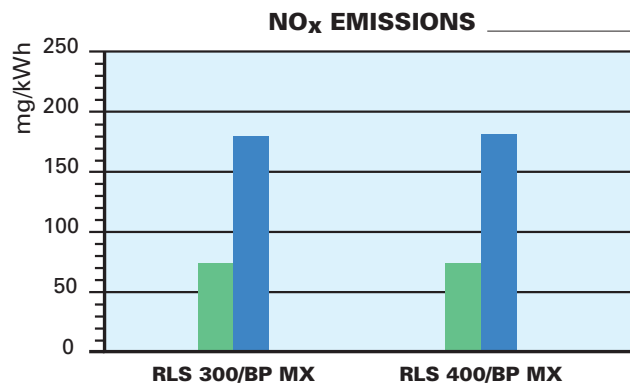



The RLS/BP MX series combustion head reduce polluting emissions thanks to their special design which optimises the air fuel mix.

### Combustion head operating diagram of RLS BP/MX series

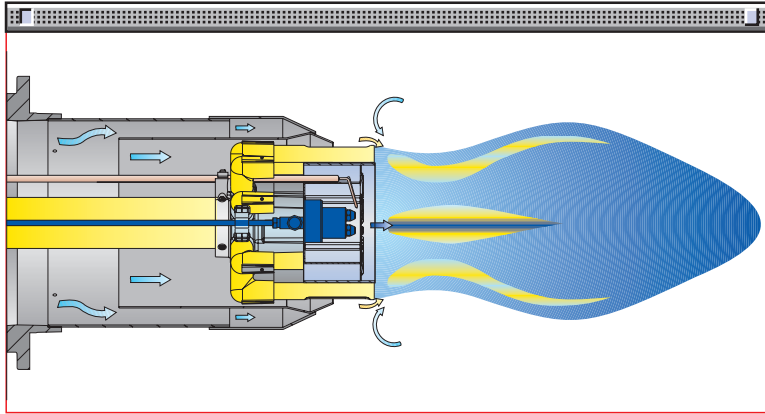

In the RLS/BP MX burners part of the gas is distributed through outlets which the remaining gas is injected directly into the centre of the flame.

This prevents no homogeneous concentrations in the flame with areas of high oxidation, producing very stable flame with gradual and progressive combustion as the flame develops, thus giving polluting emission values below even the most restrictive norm values.



## OVERALL DIMENSIONS (mm)

### BURNER

#### RLS 300-400/BP MX

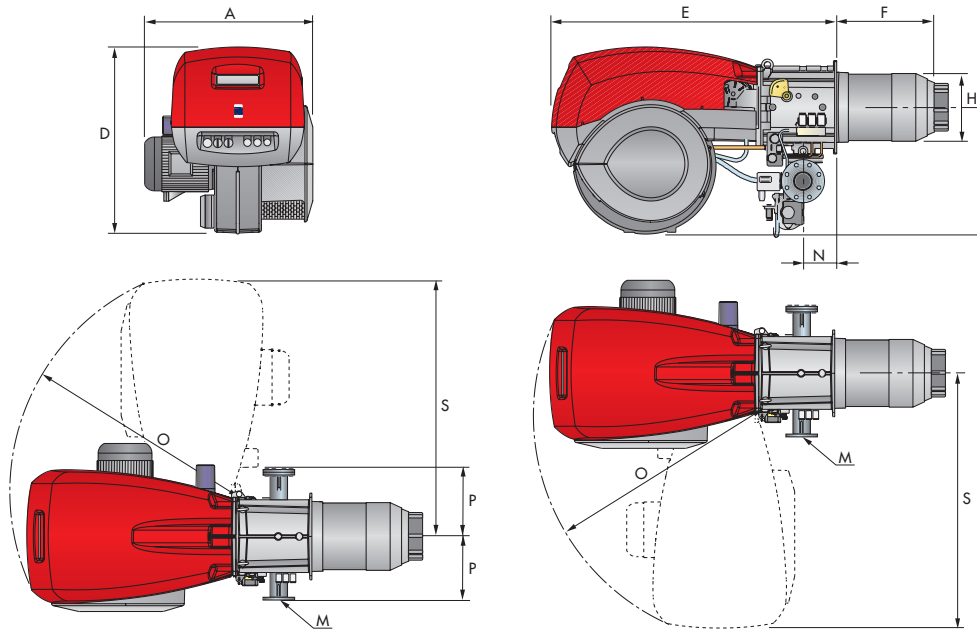

Model	A	D	E	F	H	I	M	N	O	S	P
▶ RLS 300/BP MX	720	890	1325	510	313	605	DN80	164	1055	1175	320
▶ RLS 400/BP MX	775	890	1325	510	313	605	DN80	164	1055	1175	320

### BURNER - BOILER MOUNTING FLANGE

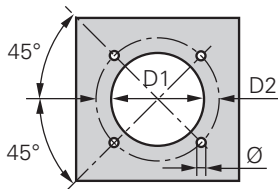

Model	D1	D2	Ø
▶ RLS 300/BP MX	325	453	M20
▶ RLS 400/BP MX	325	453	M20

### PACKAGING

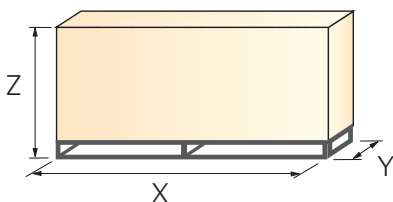

Model	X	Y	Z	kg
▶ RLS 300/BP MX	1960	970	940	240
▶ RLS 400/BP MX	1960	970	940	250



## INSTALLATION DESCRIPTION

Installation, start up and maintenance must be carried out by qualified and skilled personnel. All operation must be performed in accordance with the technical handbook supplied with the burner.

After drilling the boilerplate, using the supplied gasket as template, prepare a suitable lifting system and, after hooking onto the rings, fix burner to boiler.



### BURNER SETTING

- ▶ Install the nozzle, choosing this on the basis of the maximum boiler output and following the diagrams included in the burner instruction handbook.
- ▶ Check the position of the electrodes
- ▶ Adjust the combustion head



### HYDRAULIC AND ELECTRICAL CONNECTIONS AND START UP

- ▶ Install the gas train to the burner flange using the adapter code 3010222 if the gas train and burner hinge are situated to the same size.
- ▶ Connect the ends of the flexible pipes to the suction and return pipework using the supplied nipples.
- ▶ Make the electrical connections to the burner following the wiring diagrams included in the instruction handbook.
- ▶ Prime the pump by turning the motor.
- ▶ Proceed with the start up regulating before the gas side, so the oil side.
- ▶ On start up, check:
  - Gas pressure at the combustion head (to the max. and min. output)
  - Pressure pump (to the max. and min.)
  - Combustion quality, in terms of unburned substances and excess air.





## BURNER ACCESSORIES

### Nozzles

The nozzles must be ordered separately. The following table shows the features and codes on the basis of the maximum required fuel output.



Nozzles type 60° B					
Burner	GPH	Rated output (kg/h)			Nozzle code
		at 10 bar	at 12 bar	at 14 bar	
RLS 300-400/BP MX	12,00	44,2	48,7	53,0	<b>3009950</b>
RLS 300-400/BP MX	13,00	47,8	52,8	57,4	<b>3009951</b>
RLS 300-400/BP MX	14,00	51,5	56,9	61,8	<b>3009952</b>
RLS 300-400/BP MX	15,00	55,2	60,9	66,2	<b>3009953</b>
RLS 300-400/BP MX	16,00	58,9	65,0	70,6	<b>3009954</b>
RLS 300-400/BP MX	17,00	62,6	69,0	75,0	<b>3009955</b>
RLS 300-400/BP MX	18,00	66,2	73,1	79,4	<b>3009956</b>
RLS 300-400/BP MX	19,00	69,9	77,2	83,5	<b>3009957</b>
RLS 300-400/BP MX	20,00	73,6	81,2	88,3	<b>3009958</b>
RLS 300-400/BP MX	22,00	81,0	89,3	97,1	<b>3009959</b>
RLS 300-400/BP MX	24,00	88,3	97,5	105,9	<b>3009960</b>
RLS 300-400/BP MX	26,00	95,7	105,6	114,7	<b>3009961</b>
RLS 300-400/BP MX	28,00	103,1	113,7	123,6	<b>3009962</b>
RLS 300-400/BP MX	30,00	110,4	121,8	132,4	<b>3009963</b>
RLS 300-400/BP MX	35,00	128,8	142,1	154,5	<b>3009964</b>
RLS 300-400/BP MX	40,00	147,2	162,4	176,5	<b>3009965</b>
RLS 300-400/BP MX	45,00	165,6	182,7	198,6	<b>3009966</b>
RLS 300-400/BP MX	50,00	184,0	203,0	220,7	<b>3009967</b>
RLS 300-400/BP MX	55,00	202,4	223,4	242,7	<b>3009968</b>
RLS 300-400/BP MX	60,00	220,8	243,7	264,8	<b>3009969</b>
RLS 300-400/BP MX	65,00	239,2	264,0	286,9	<b>3009970</b>
RLS 300-400/BP MX	70,00	257,6	284,3	309,0	<b>3009971</b>



### Accessories for modulating operation

To obtain modulating operation, the RLS/BP MX series of burners requires a regulator with three point outlet controls. The following table lists the accessories for modulating operation with their application range.



Burner	Regulator type	Regulator code
RLS 300-400/BP MX	RWF 40 Basic version with 3 position output	<b>3010356</b>
RLS 300-400/BP MX	RWF 40 High version with additional modulating output and RS 485 Interface	<b>3010357</b>

The relative temperature or pressure probes fitted to the regulator must be chosen on the basis of the application.



Burner	Probe type	Range (°C) (bar)	Probe code
RLS 300-400/BP MX	Temperature PT 100	-100 ÷ 500°C	<b>3010110</b>
RLS 300-400/BP MX	Pressure 4 ÷ 20 mA	0 ÷ 2,5 bar	<b>3010213</b>
RLS 300-400/BP MX	Pressure 4 ÷ 20 mA	0 ÷ 16 bar	<b>3010214</b>

Depending on the servomotor fitted to the burner, a three-pole potentiometer (1000 Ω) can be installed to check the position of the servomotor. The KITS available for the various burners are listed below.



Burner	Potentiometer kit code
RLS 300-400/BP MX	<b>3010021</b>

### Continuous ventilation kit

If the burner requires continuous ventilation in the stages without flame, a special kit is available as given in the following table:



Continuous ventilation kit	
Burner	Kit code
RLS 300-400/BP MX	<b>3010030</b>

### Seal control kit

To test the valve seals on the gas train, a special "seal control kit" is available. The valve seal control device is compulsory (EN 676) on gas trains to burners with a maximum output over 1200 kW. The seal control is type VPS 504.



Seal control kit		
Burner	Gas train	Kit code
RLS 300-400/BP MX	VGDF 50, VGDF 65, VGDF 80, VGDF 100	<b>3010367</b>



### Sound proofing box

If noise emission needs reducing even further, sound-proofing boxes are available, as given in the following table:

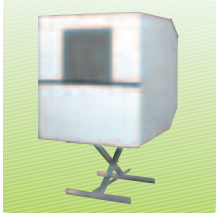

Sound proofing box		
Burner	Box type	Box code
RLS/BP MX	C7	3010376



Fuel remote selection kit	
Burner	Box code
RLS 300-400/BP MX	3010372



## GAS TRAIN ACCESSORIES



### Adapters

Below are given the adapters than can be fitted on the various burners:

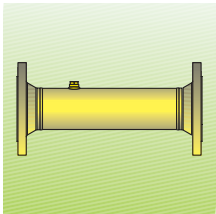

Adapters			
Burner	Gas train	Dimensions	Adapter code
RLS/BP MX	VGDF 65 - VGDF 80 VGDF 100- VGD 50	80x80x400	3010222

## SPECIFICATION



A specific index guides your choice of burner from the various models available in the RLS/BP MX series. Below is a clear and detailed specification description of the product.



### DESIGNATION OF SERIES

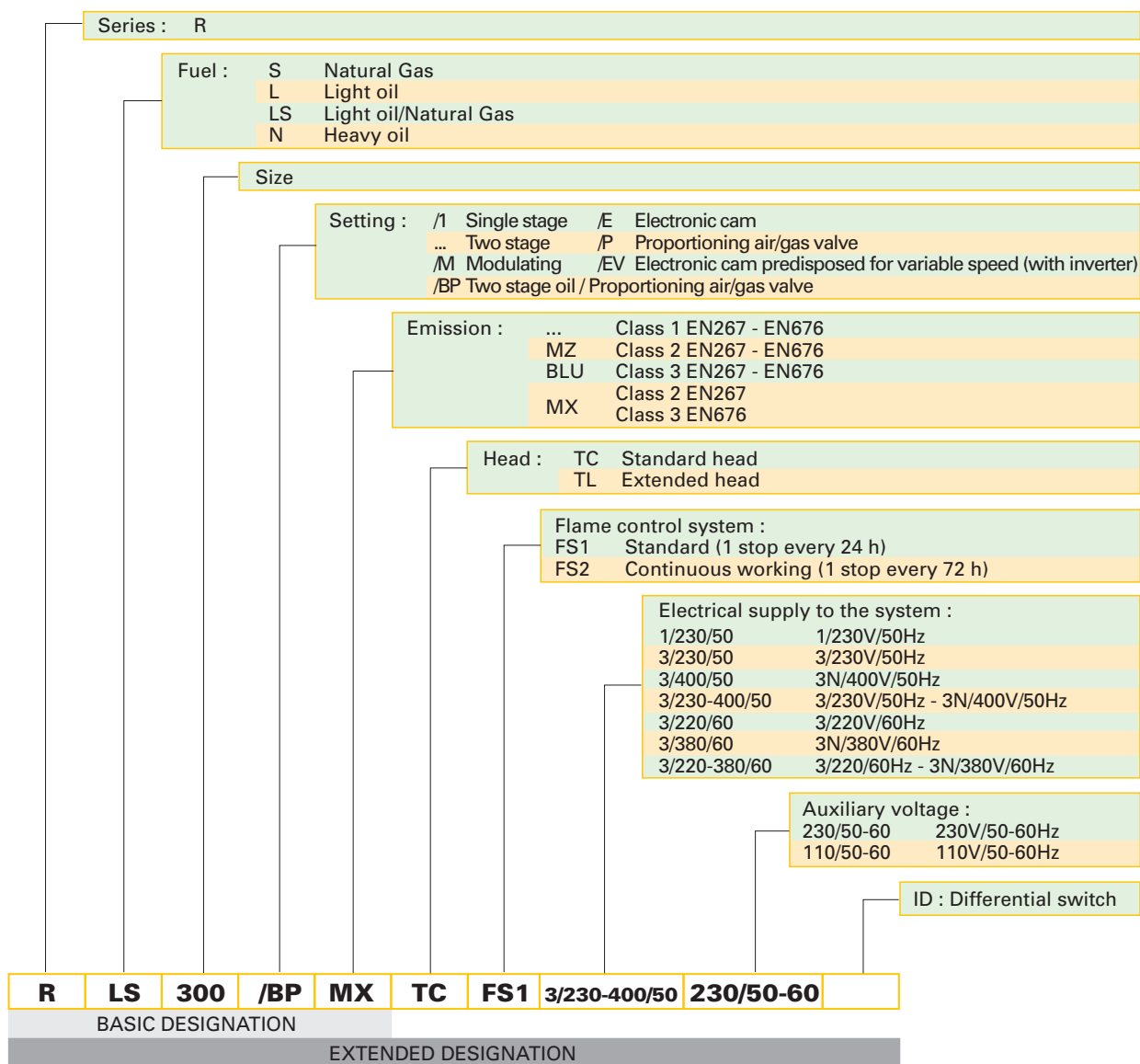

### AVAILABLE BURNER MODELS

RLS 300/BP MX TC FS1 230-400/50 230/50-60

RLS 400/BP MX TC FS1 400/50 230/50-60

**Other versions are available on request.**



## ▶ PRODUCT SPECIFICATION

### **Burner**

Monoblock forced draught gas burner with “two stage progressive” or “modulating” operation, fully automatic, made up of:

- Fan with reverse curve blades high performance with low sound emissions
- Air suction circuit lined with sound-proofing material
- Air damper for air setting controlled by a high precision servomotor
- Air pressure switch
- Fan starting motor at 2800 rpm, three-phase 230/400 - 400/690 V with neutral, 50Hz
- Low emission combustion head, that can be set on the basis of required output, fitted with:
  - stainless steel end cone, resistant to corrosion and high temperatures
  - ignition electrodes
  - flame stability disk
- Maximum gas pressure switch, with pressure test point, for halting the burner in the case of over pressure on the fuel supply line
- Module for air/fuel setting and output modulation with separated PID control of temperature or pressure, available as accessory for RLS/BP MX model
- Flame control panel for controlling the system safety
- Ionization probe for flame detector
- Star/triangle starter for the fan motor (version with motor electrical power 7,5 kW)
- Main electrical supply terminal board
- Burner on/off switch
- Auxiliary voltage led signal
- Burner working led signal
- Contacts motor and thermal relay with release button
- Motor internal thermal protection
- Motor failure led signal
- Burner failure led signal and lighted release button
- Emergency button
- Coded connection plugs-sockets
- Burner opening hinge
- Lifting rings
- IP 54 electric protection level
- Gears pump for high pressure fuel supply
- Pump starting motor
- Oil safety valves
- Three oil valves (1st and 2nd stage 3rd safety valve)
- Flame control panel
- UV photocell for flame detection
- Burner on/off selection switch
- Oil/Gas selector
- Flame inspection window
- Burner opening hinge.

### **Conforming to:**

- 89/336/EEC directive (electromagnetic compatibility)
- 73/23/EEC directive (low voltage)
- 90/396/EEC directive (gas)
- EN 676 (gas burners).

### **Standard equipment:**

- 1 flange gasket
- 4 screws for fixing the flange
- 1 thermal screen
- 4 screws for fixing the burner flange to the boiler
- 2 flexible pipes for connection to the oil supply network
- 2 nipples for connection to the pump with gaskets.
- Instruction handbook for installation, use and maintenance
- Spare parts catalogue



**Available accessories to be ordered separately:**

- Pressure probe 0 ÷ 2.4 bar
- Pressure probe 0 ÷ 16 bar
- Temperature probe -100 ÷ 500°C
- RWF 40 for RLS/BP MX
- Potentiometer kit
- Continuous ventilation kit
- Adapter
- Seal control kit
- Sound proofing box
- Remote fuel selection



RIELLO S.p.A. - Via degli Alpini, 1 - 37045 LEGNAGO (VR) Italy  
Tel. ++39.0442630111 - Fax ++39.044221980

Internet: <http://www.rielloburners.com> - E-mail: [info@rielloburners.com](mailto:info@rielloburners.com)



Since the Company is constantly engaged in the production improvement, the aesthetic and dimensional features, the technical data, the equipment and the accessories can be changed.  
This document contains confidential and proprietary information of RIELLO S.p.A.  
Unless authorised, this information shall not be divulged, nor duplicated in whole or in part.