

LOW NO_x TWO STAGE GAS BURNERS

▶ **GULLIVER BSD SERIES**

▶ BS1D	16/19 ÷ 52 kW
▶ BS2D	35/40 ÷ 91 kW
▶ BS3D	65/75 ÷ 189 kW
▶ BS4D	110/140 ÷ 246 kW



The Riello Gulliver BSD series of two stage gas burners, is a complete range of Low NO_x emission products, developed to respond to any request for home heating, conforming to the most severe standards regarding the reduction of polluting emissions.

This series of burners is available in four different models with an output ranging from 16 to 246 kW, divided in four different structures.

All the models use the same components designed by Riello for the Gulliver series. The high quality level guarantees safe working. The Gulliver BSD burners are fitted with a microprocessor - based flame control panel, with diagnostic functions.

In developing these burners, special attention was paid to reducing noise, the ease of installation and adjustment, to obtaining the smallest size possible to fit into any sort of boiler available on the market.

Two stage working guarantees high level performance from the thermal unit.

All the models are approved by the EN 676 European Standard and LRV 92 Swiss standards, and conform to BImSchV 1996 and European Directives, Gas Appliance, EMC, Low Voltage, Boiler Efficiency.

All the Gulliver BSD burners are tested before leaving the factory.



TECHNICAL DATA

Model		▼ BS1D	▼ BS2D	▼ BS3D	▼ BS4D
Bumer operation mode		Two stage			
Modulation ratio at max. output		--			
Servomotor	type	R.B.L.			
	run time	5 ÷ 25			
Heat output	kW	16/19 - 52	35/40 - 91	65/75 - 189	110/140 - 246
	Mcal/h	13,8/16,3 - 44,7	30,1/34,4 - 78,2	55,9/64,5 - 162,5	94,6/120,4 - 211,6
Working temperature		°C min./max. 0/40			
Net calorific value G20 gas		kWh/Nm ³ 10			
G20 gas density		kg/Nm ³ 0,71			
G20 gas delivery		1,6/1,9 - 5,2	3,5/4 - 9,1	6,5/7,5 - 18,9	11/14 - 24,6
Net calorific value G25 gas		kWh/Nm ³ 8,6			
G25 gas density		kg/Nm ³ 0,78			
G25 gas delivery		1,9/2,2 - 6	4/4,7 - 10,6	7,6/8,7 - 22	12,8/16,3 - 28,6
Net calorific value LPG gas		kWh/Nm ³ 25,8			
LPG gas density		kg/Nm ³ 2,02			
LPG gas delivery		0,6/0,7 - 2	1,3/1,6 - 3,5	2,5/2,9 - 7,3	4,3/5,4 - 9,5
Fan		type Centrifugal with forward curve blades			
Air temperature		max °C 40			
Electrical supply		Ph/Hz/V 1/50/230 ±10%			
Auxiliary electrical supply		Ph/Hz/V --			
Control box		type MG 569			
Total electrical power		0,150	0,180	0,350	0,530
Auxiliary electrical power		kW --			
Protection level		IP X0D			
Motor electrical power		0,09	0,09	0,15	0,25
Rated motor current		0,64	0,67	1,4	2
Motor start up current		2,6	2,7	5,6	8
Motor protection level		IP 20			
Ignition transformer		type Incorporated in the control box			
		V1 - V2 (-) - 8 kV			
		I1 - I2 (-) - 12 mA			
Operation		Intermittent (at least one stop every 24 h)			
Sound pressure		61	62	66	71
Sound power		W --			
CO emission		mg/kWh < 40			
NOx emission		mg/kWh < 80			
Directive		90/396/EEC, 89/336/EEC, 73/23/EEC, 98/37/EEC, 92/42/EEC			
Conforming to		EN 676 - LRV 92 - BImSchV 1996			
Certification		CE - 0085 AQ0409 BUWAL - Nr.100010			

Reference conditions:

Temperature: 20°C

Pressure: 1013,5 mbar

Altitude: 100 m a.s.l.

Noise measured at a distance of 1 meter.

Since the Company is constantly engaged in the production improvement, the aesthetic and dimensional features, the technical data, the equipment and the accessories can be changed.

This document contains confidential and proprietary information of RIELLO S.p.A. Unless authorised, this information shall not be divulged, nor duplicated in whole or in part.

FIRING RATES

EN 676

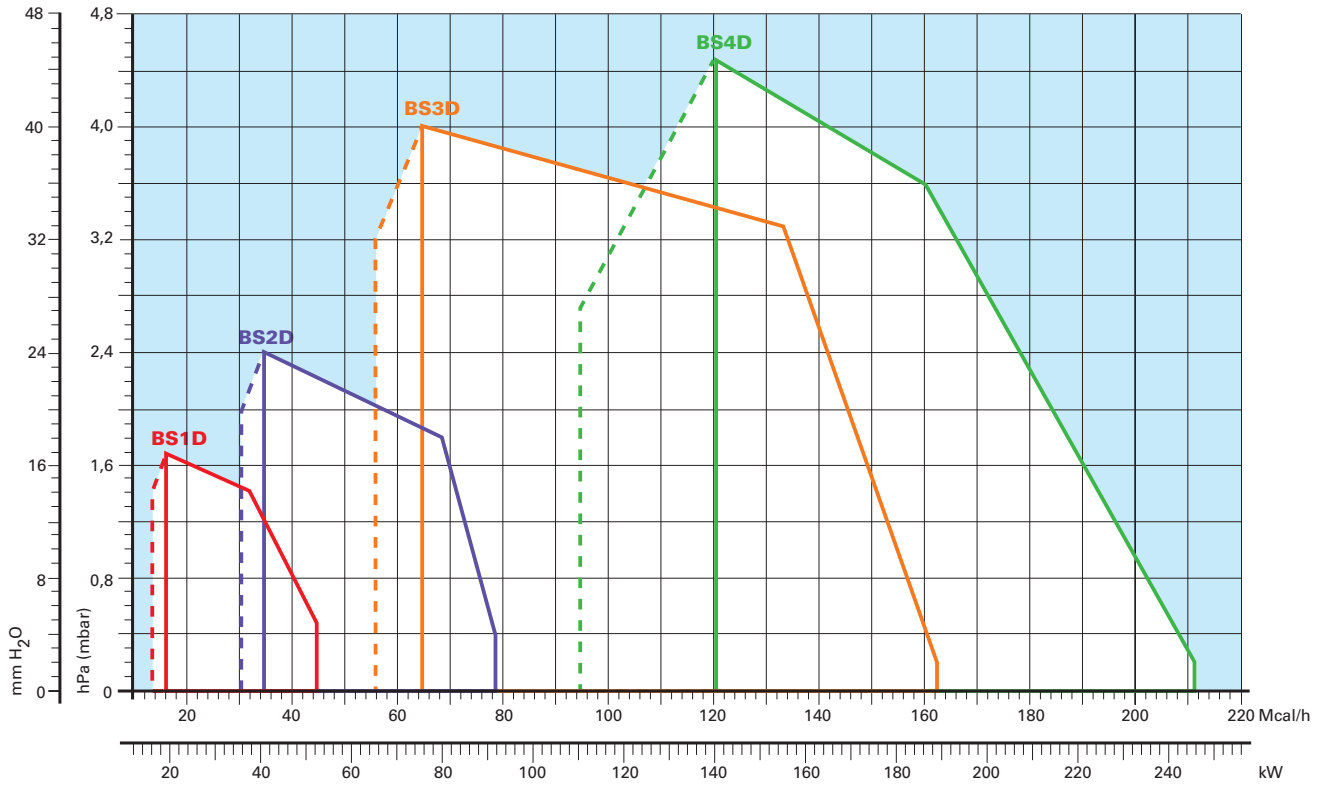

LRV 92

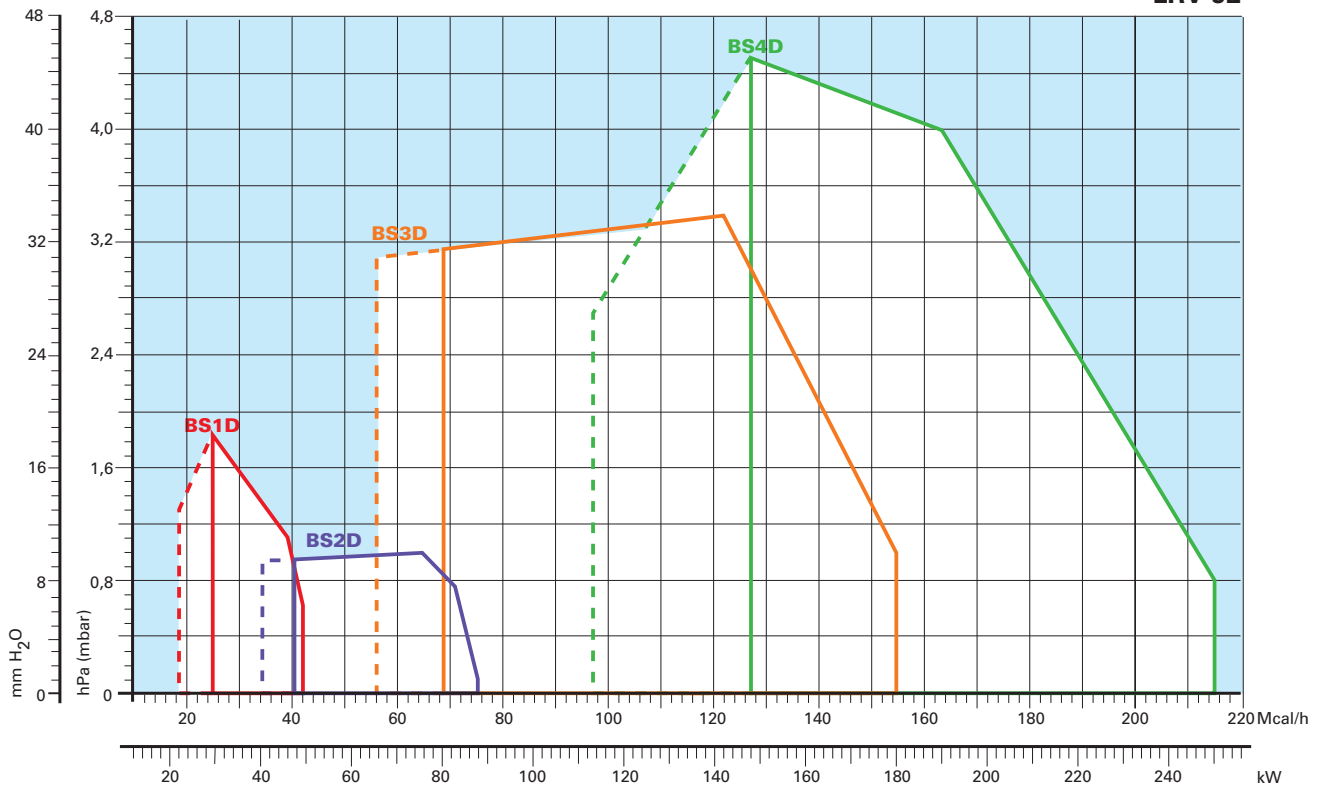

 Useful working field for choosing the burner

 1st stage operation range

Test conditions conforming to EN 676 and LRV 92:

Temperature: 20 °C
 Pressure: 1013,5 mbar
 Altitude: 100 m a.s.l.





FUEL SUPPLY

GASTRAIN

The burners are set for fuel supply from either the right or left hand sides.

Depending on the fuel output and the available pressure in the supply line, you should check the correct gas train to be adapted to the system requirements.

The gas train is Multibloc type, containing the main components in a single unit and it can be fitted with the valve seal control (as an accessory).



Gas train installed on the burner

MBZRDLE 405 - 407 - 410 - 412

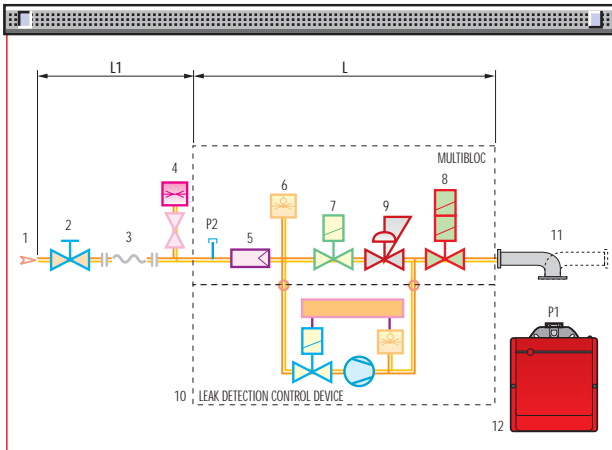

1	Gas delivery pipe
2	Manual valve
3	Vibration damping joint
4	Gas pressure gauge
5	Filter
6	Gas pressure switch
7	Safety solenoid
8	Adjustment solenoid 1st and 2nd stage: firing delivery adjustment (rapid opening) maximum delivery adjustment (slow opening)
9	Pressure regulator
10	Leak detection control device for valves 7 and 8 (accessory)
11	Gas train-burner adapter
12	Burner
P1	Combustion head pressure
P2	Upstream pressure from the filter
L	Gas train supplied separately
L1	To be performed by the installer

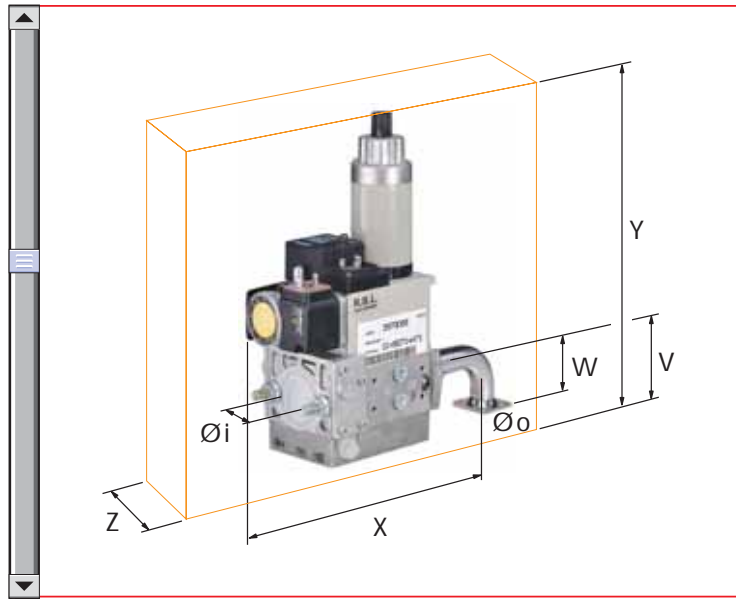

The dimensions of the gas trains vary depending on their construction features.

The following table shows the dimensions of the gas trains that can be fitted to Gulliver BSD burners, intake diameter and the coupling flange to the burner.

	Name	Code	Ø i	Ø o	X mm	Y mm	W mm	Z mm	V mm	mbar max*
MULTIBLOC	MBZRDLE 405	3970539	1/2"	FLANGE 1	246	257	45	120	46	300
	MBZRDLE 405	3970540	3/4"	FLANGE 2	236	257	47	120	46	300
	MBZRDLE 407	3970538	3/4"	FLANGE 2	236	257	47	120	46	300
	MBZRDLE 407	3970541	3/4"	FLANGE 3	236	257	47	120	46	300
	MBZRDLE 410	3970542	1" 1/4	FLANGE 3	259	315	47	145	55	300
	MBZRDLE 412	3970543	1" 1/4	FLANGE 3	259	315	47	145	55	300

* max inlet gas pressure (mbar)

PRESSURE DROP DIAGRAM

The diagrams indicate the minimum pressure drop of the burners with the various gas trains that can be matched with them; the value thus calculated represents the minimum required input pressure to the gas train.

NATURAL GAS

BS1D

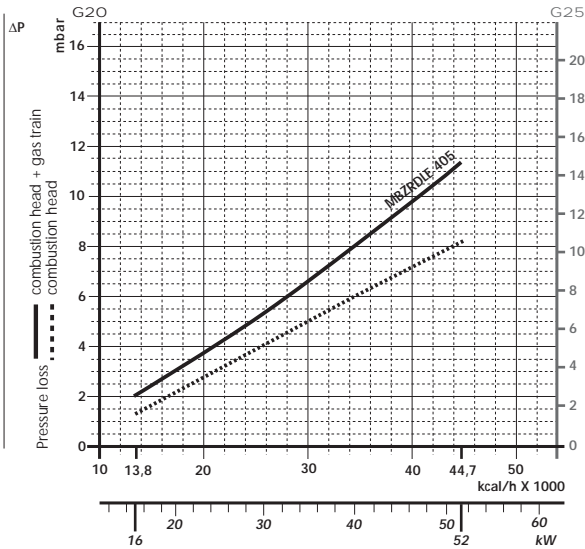

LPG

BS1D

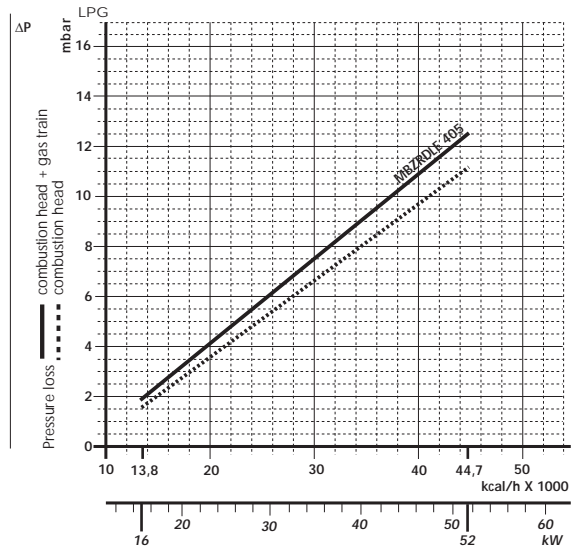

Gas Train	Code	Plug and socket
MBZRDLE 405	3970539	•

BS2D

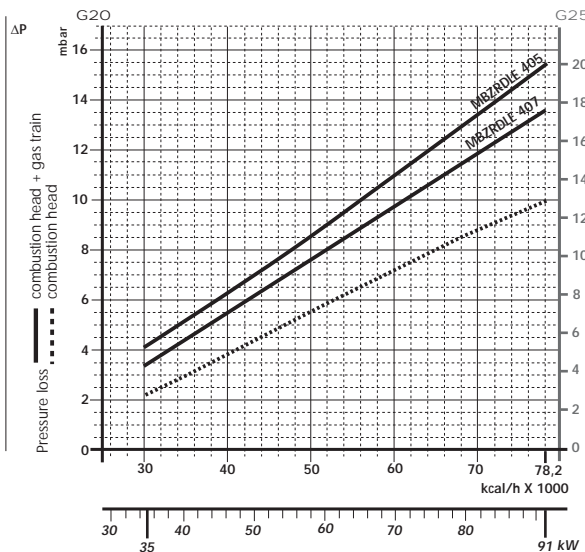

BS2D

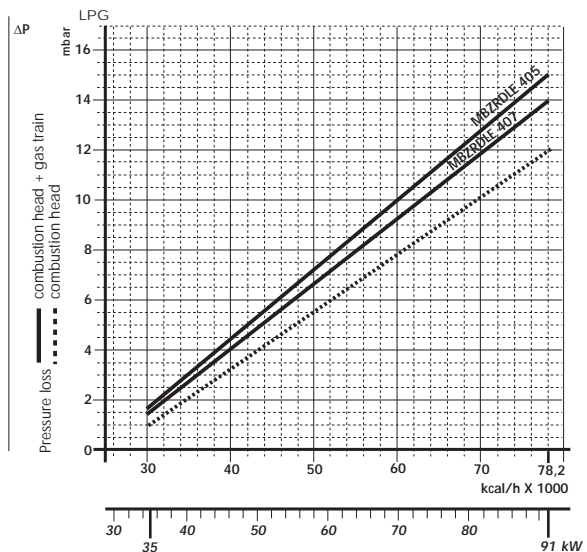

Gas Train	Code	Plug and socket
MBZRDLE 405	3970540	•
MBZRDLE 407	3970538	•



NATURAL GAS

BS3D

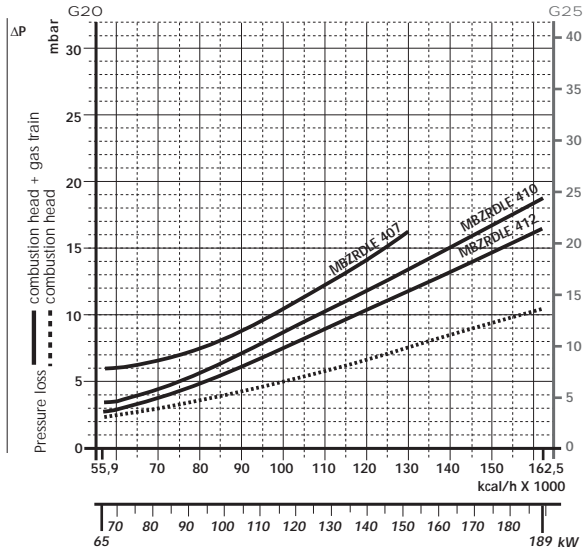

Gas Train	Code	Output	Plug and socket
MBZRDLE 407	3970541	≤ 150 kW *	•
MBZRDLE 410	3970542	-	•
MBZRDLE 412	3970543	-	•

* with natural gas.

LPG

BS3D

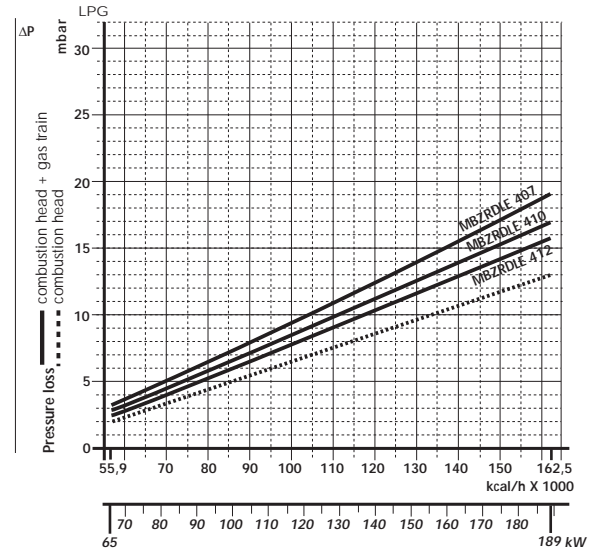

BS4D

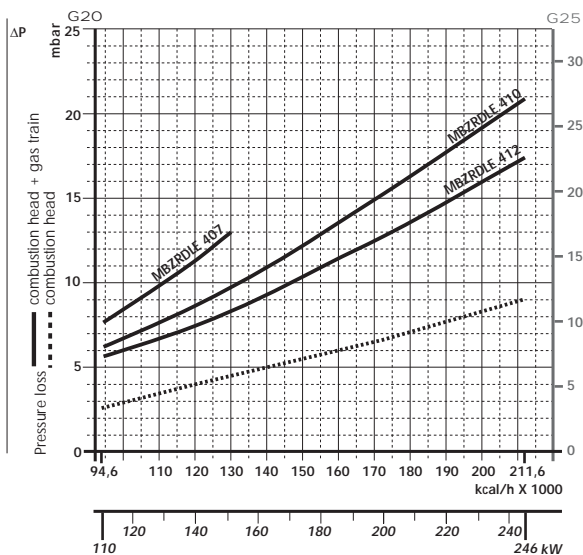

Gas Train	Code	Output	Plug and socket
MBZRDLE 407	3970541	≤ 150 kW *	•
MBZRDLE 410	3970542	-	•
MBZRDLE 412	3970543	-	•

* with natural gas.

BS4D

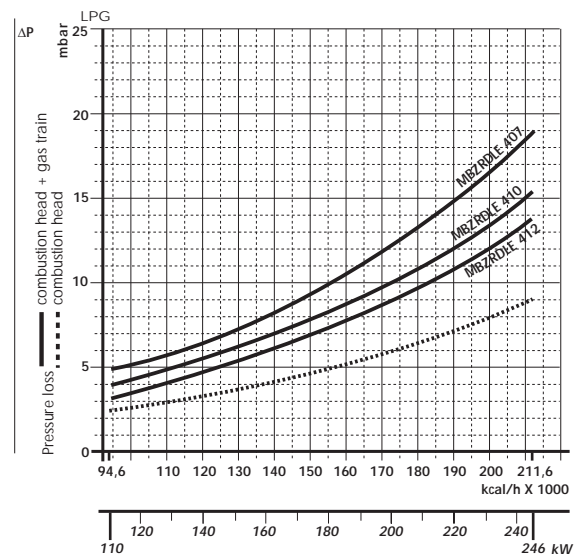

note For pressure levels different from those indicated above, please contact Riello Burners Technical Office.
 In LPG plants, Multibloc gas trains do not operate below 0°C.
 They are only suitable for gaseous LPG (liquid hydrocarbons destroy the seal materials).



VENTILATION

The different ventilation circuits always ensure low noise levels with high performance of pressure and air delivery, inspite of their compact size.



Air suction



Air pressure switch

The burners are fitted with an adjustable air pressure switch, conforming to EN 676 standards.

COMBUSTION HEAD

The combustion head in Gulliver BSD burners is the result of an innovative design, which allows combustion with low polluting emissions, while being easy to adapt to all the various types of boilers and combustion chambers.

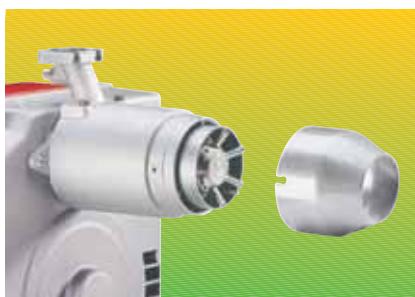
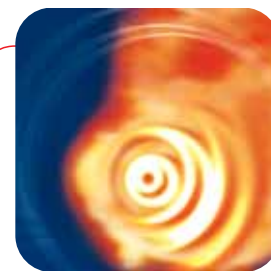

Combustion head



Mobile flange

Thanks to the use of a mobile coupling flange, the penetration of the head into the combustion chamber can be adjusted.

Simple adjustment allows the internal geometry of the combustion head to be adapted to the burner output.

Dimensions of the flame

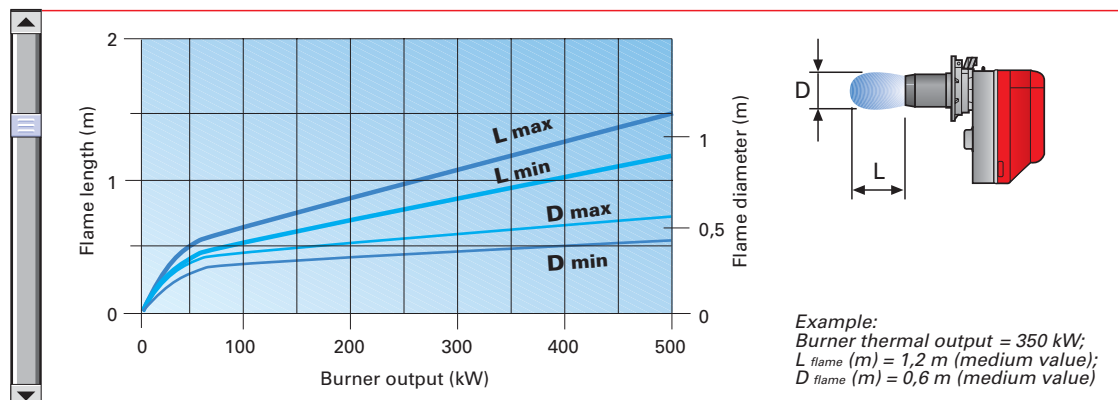



ADJUSTMENT



BURNER OPERATION MODE

All these models are two stage operation. The Gulliver BSD series of two stage burners allows operating at both full and reduced output, with consequent reduction in turning the burner on and off, their giving better performance to the boiler. During stand-by, the air damper is completely closed (controlled by an electric servomotor) and prevents heat loss due to the flue draught.

"Two stage" operation

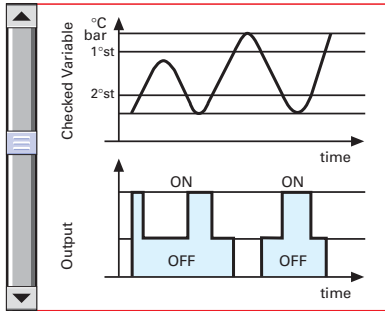

Air damper adjustment



Air-damper opening mechanism



Air-damper opening mechanism

All Gulliver BSD series burners are fitted with a new microprocessor control panel for the supervision during intermittent operation. For helping the commissioning and maintenance work, there are two main elements:



The lock-out reset button is the central **operating element** for resetting the burner control and for activating / deactivating the diagnostic functions.



The multi-color LED is the central **indication element** for visual diagnosis and interface diagnosis.

Both elements are located under the transparent cover of lock-out reset button, as showed below.

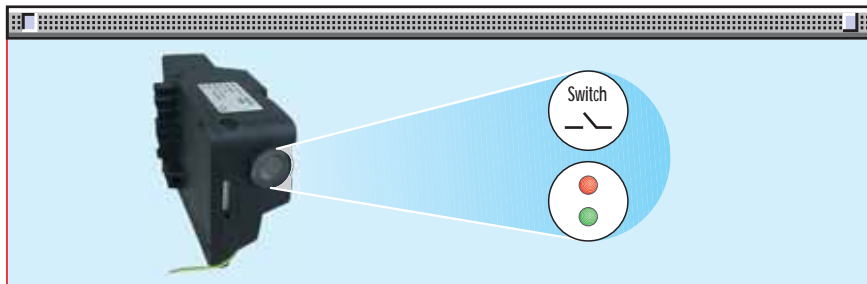

There are two diagnostic choices, for indication of operation and diagnosis of fault cause:
- visual diagnosis :

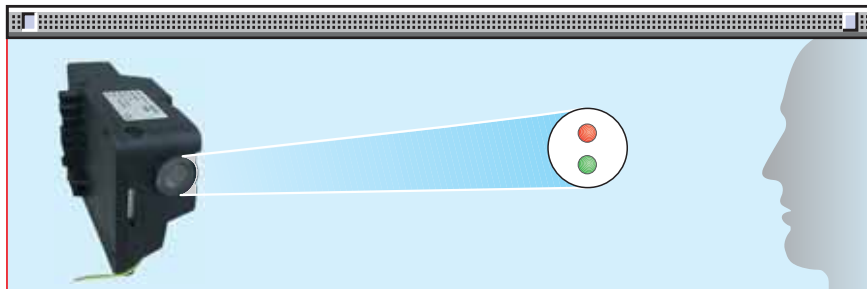

- interface diagnosis :

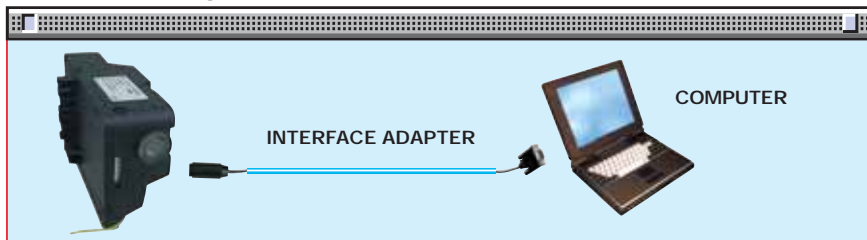

by the interface adapter and a PC with dedicated software.

Indication of operation:

In normal operation, the various statuses are indicated in the form of colour codes according to the table below.

Color code table	
Operation statuses	Color code
Stand-by	○ Led off
Pre-purging	● Green
Ignition phase	● Green
Flame OK	● Green
Post purge	● Green
Undervoltage, built-in fuse	○ Led off
Fault, alarm	● Red

Diagnosis of fault causes:

After lock-out has occurred, the red signal lamp is steady on. In this status, the visual fault diagnosis according to the error code table can be activated by pressing the lock-out reset button for > 3 seconds. The control box sends a sequence of pulses that are repeated at 2-second intervals. The interface diagnosis (with adapter) can be activated by pressing again the lock-out button for > 3 seconds.

Example of blinks sequence:



Error code table	
Blink code	Possible cause of fault
2 blinks ● ●	No flame at the end of safety time: - faulty or soiled gas valves - faulty ionisation probe - poor adjustment of burner, no gas - faulty ignition - neutral / phase exchange
3 blinks ● ● ●	Air pressure switch does not close or is already closed before heat demand: - faulty air pressure switch - air pressure switch incorrectly regulated
4 blinks ● ● ● ●	Presence of flame: - in stand-by position - with thermostat of heat demand in idle or working position - during pre-purge - during post-purge
6 blinks ● ● ● ● ● ●	Loss of air pressure: - during pre-purge - during or after safety time
7 blinks ● ● ● ● ● ● ●	Loss of flame during operations after n°3 attempts of re-cycle: - faulty or soiled gas valves - faulty ionisation probe - short circuit between ionisation probe and earth of the burner - poor adjustment of burner, no fuel

The MG569 digital control box gives some other advantages:

Post ignition (during safety time)

The spark ignition is present during all safety time

Adjustable post purge

The Post-purge is a function that maintains air ventilation even after the burner is switched off. Post-purge time can be set to a maximum of 6 minutes.

This function can be activated and set in a very easy way by pressing repeatedly the reset button; after 5 seconds the control box automatically shows the minutes set by the red LED flashing (1 pulse = post-ventilation for 1 minute).

If during post-purge there is a new request for heat, it is halted and a new operating cycle starts. The control box leaves the factory with the setting 0 minutes (no post-ventilation).

Remote lock-out reset

The 'Remote lock-out reset' is a function that allows to reset the control-box operation from a remote position. In the burner packages will be included a particular connector to remote the reset signal. The maximum length of connection must be 20 m.

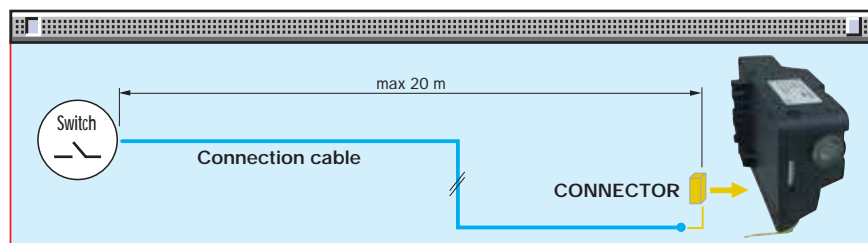

START UP CYCLE

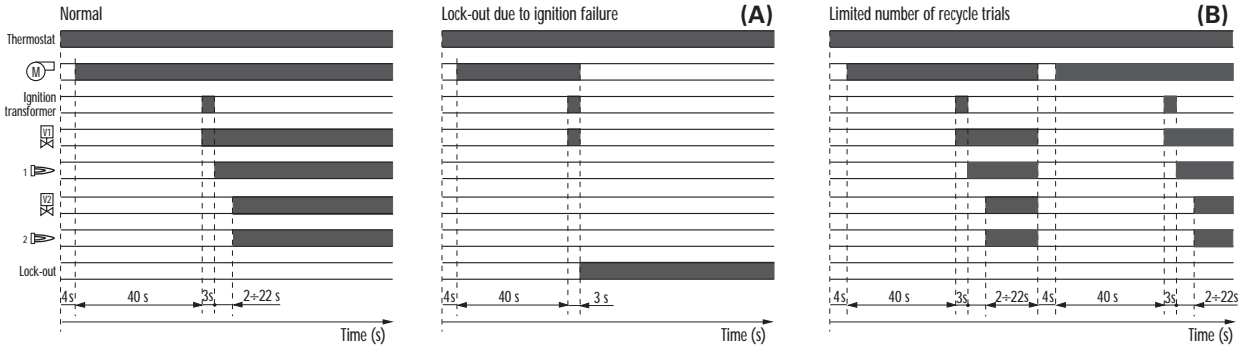

(A) Lock-out is shown by a led on the appliance.

(B) Total number of recycle trials is 3.

Correct operation

- 0s Start of heat demand the burner begins the ignition cycle
- 0s+4s The burner is in stand-by
- 4s+44s Pre-purge with opened air damper
- 44s Ignition 1st stage
- 49s+69s Ignition 2nd stage.

Lock-out due to ignition failure

If the flame does not light within the safety limit (~ 3s) the burner locks-out.

Re-cycle

The burner permits maximum three repetitions of complete ignition cycle if there is flame failure during operation. The burner goes in safety shut-down within one second. The final action at the last trial following at last flame failure is a lock-out.



WIRING DIAGRAMS

Electrical connections must be made by qualified and skilled personnel, in conformity with the local regulations in force.



Control-box fitted with ignition transformer

"TWO STAGE" OPERATION

Burner electrical wiring

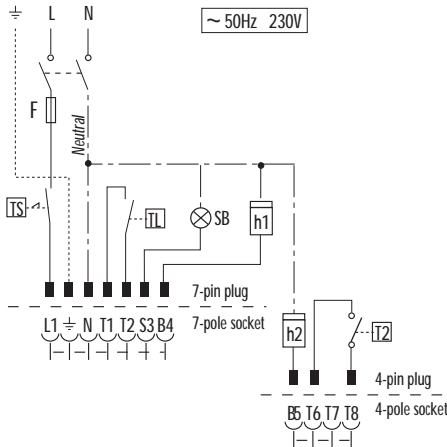

Gas train electrical wiring

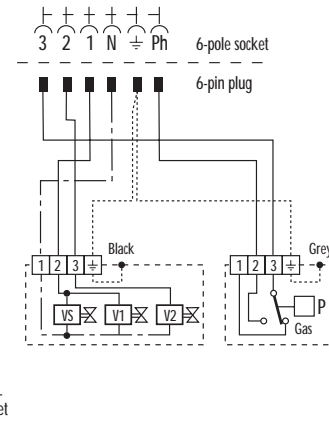

- h1** - One stage counter hours (230V 0,1A max)
- h2** - Two stage counter hours (230V 0,1A max)
- SB** - Remote lock out signal (230V 0,1A max)
- TL** - Limit thermostat
- TS** - Safety thermostat (manual reset)
- T2** - Two stage thermostat
- VS** - Safety valve
- V1** - One stage valve
- V2** - 2nd stage valve
- P** - Gas pressure switch
- F** - Fuse

The following table shows the supply lead sections and types of fuse to be used.

Model	▼ BS1D	▼ BS2D	▼ BS3D	▼ BS4D
	230V	230V	230V	230V
F A	6	6	6	T6
L mm ²	1	1	1	1

F = Fuse
L = Lead section

EMISSIONS

The burners in the Gulliver BSD series guarantee controlled combustion, reducing emissions of both CO and NOx, this combustion control is due to the recirculation of the combustion products in the chamber (thanks to different combustible air flow speeds) and to the *fuel staging* technique (thanks to the special geometry of the gas nozzles).

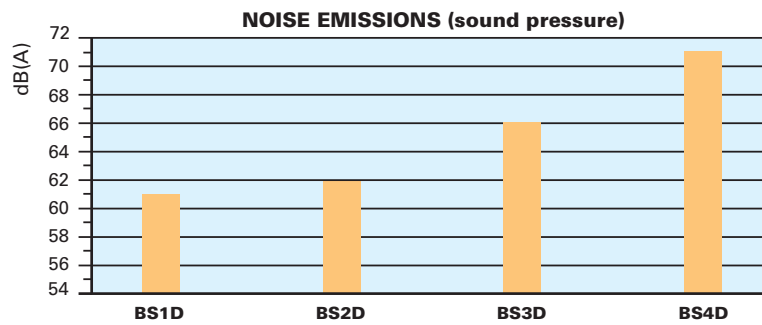
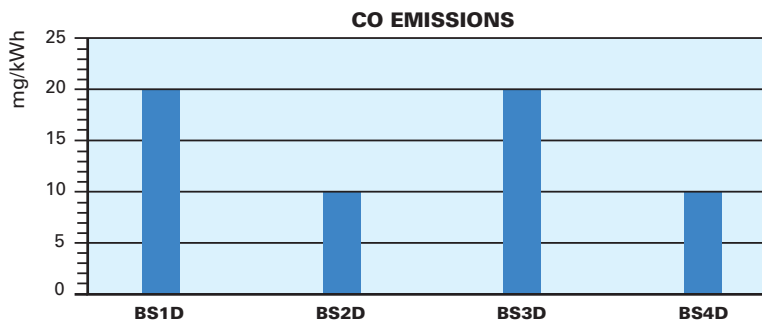
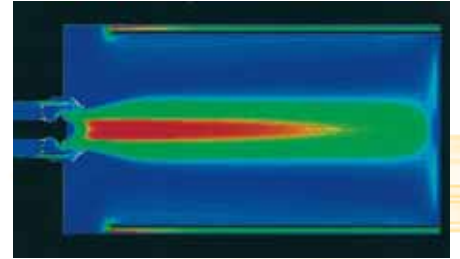
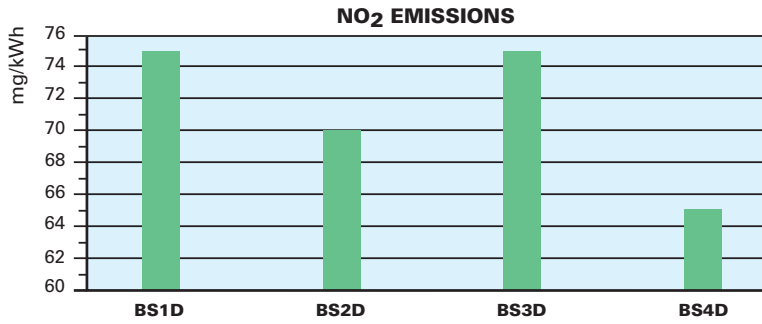

The emission data have been measured in the various models at maximum output, in conformity with EN 676 standard.

Special attention has been paid to noise reduction. All models are fitted with sound-proofing material inside the cover.





OVERALL DIMENSIONS (mm)

These models are distinguished by their reduced size, in relation to their output, which means they can be fitted to any boiler on the market.

BURNER

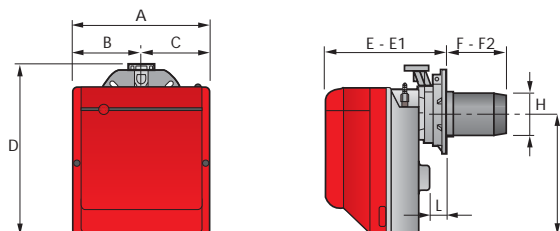

Model	A	B	C	D	E	E1	F	F2	H	I	L
▶ BS1D	234	122	112	295	230	276	116	70	89	210	41
▶ BS2D	255	125,5	125,5	325	238	252	114	100	106	230	45
▶ BS3D	300	150	150	391	262	280	128	110	129	285	45
▶ BS4D	300	150	150	392	278	301	168	145	137	286	45

BURNER-BOILER MOUNTING FLANGE

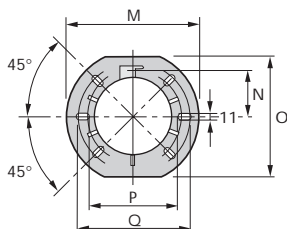

Model	M	N	O	P	Q
▶ BS1D	192	66	167	140	170
▶ BS2D	192	66	167	140	170
▶ BS3D	216	76,5	201	160	190
▶ BS4D	218	80,5	203	170	200

PACKAGING

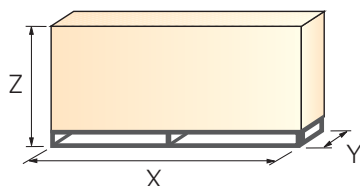

Model	X	Y	Z	kg
▶ BS1D	385	268	340	11
▶ BS2D	395	288	365	12
▶ BS3D	440	335	430	16
▶ BS4D	500	335	430	18

INSTALLATION DESCRIPTION

Installation, start up and maintenance must be carried out by qualified and skilled personnel.

The burner is set in the factory on standard calibration (minimum output). If necessary adjustments can be made on the basis of the maximum output of the boiler. All operations must be performed as described in the technical handbook supplied with the burner.

- ▶ The mobile flange allows adapting the length of the combustion head to the combustion chamber (flame inversion or 3 smoke cycles) and to the thickness of the boiler panel.



▶ BURNER SETTING

- ▶ The adjustment of the 1st stage air damper position can be easily carried out by setting the air damper motor and following the manual instruction.



- ▶ The second stage position of the air damper can be adjusted without removing the burner cover.



- ▶ Head setting is easy and aided by a graduated scale; a test point allows reading the air pressure in the combustion head.



- ▶ Gulliver BSD burners are fitted with an air pressure switch which, in accordance with EN 676 standards, can be adjusted by the installer using a graduated selector, on the basis of the effective working conditions.





MAINTENANCE AND ELECTRICAL CONNECTIONS

- ▶ Maintenance is easily solved because the combustion head can be disassembled without having to remove the burner and gas train from the boiler.
- ▶ The 7-pole socket is incorporated in the control box, the 4-pole socket (for connecting the 2nd stage thermostat to the hour meter) and the 6-pole socket (for connection to the gas train) are already connected to the equipment and fixed into the burner.
The 7 and 4-pin plugs are also supplied for connection to the boiler.



BURNER ACCESSORIES



Extended head kit

“Standard head” burners can be transformed into “extended head” versions by using the special kit.

Below the KITS available for the various burners are listed, showing the original and the extended lengths.

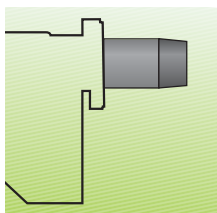

Extended head kit			
Burner	Standard head length (mm)	Extended head length (mm)	Kit Code
BS2D (long)	100 ÷ 114	170 ÷ 180	3001007
BS2D (extra long)	100 ÷ 114	270 ÷ 280	3001008
BS3D	110 ÷ 128	267 ÷ 282	3001009
BS4D	145 ÷ 168	302 ÷ 317	3001016

LPG kit

For burning LPG gas, a special kit is available to be fitted to the combustion head on the burner, as shown in the following table:



LPG kit		
Burner	Kit code for standard head	Kit code for extended head
BS1D	3001003	-
BS2D	3001004	3001004
BS3D	3001005	3001005
BS4D	3001011	3001011

Alternative combustion head kit

To extend the adaptability of Gulliver BSD burners to any sort of application, alternative combustion heads have been developed, for example, to overcome situations of combustion instability which could arise with certain heat generators. These heads cause a very limited increase in NOx emissions, due to the slower air flow.

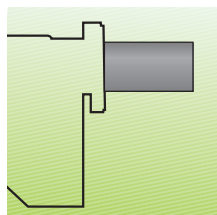

Alternative combustion head kit	
Burner	Kit Code
BS1D	3001059
BS2D	3001064
BS3D	3001060
BS4D	3001070

Ground fault interrupter kit

A "Ground fault interrupter kit" is available as a safety device in case of electrical system fault. It is supplied with burners with pin plug.



Ground fault interrupter kit	
Burner	Kit code
BS1D - BS2D - BS3D - BS4D	3001180

Multibloc rotation kit

There is a special kit available that can be used to install the burner turned 180°. This kit is designed to ensure the gas train valve properly.

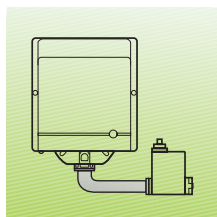

Multibloc rotation kit	
Burner	Kit code
BS1D	3001179
BS2D	3001177
BS3D - BS4D	3001178

7-pin plug kit

If necessary a 7-pin plug kit is available (in packaging of n. 5 pieces).

7-pin plug kit	
Burner	Kit code
BS1D - BS2D - BS3D - BS4D	3000945

Interface adapter kit

To connect the flame control panel to a personal computer for the transmission of operation, fault signals and detailed service information, an interface adapter with PC software are available.



Interface adapter kit	
Burner	Kit code
BS1D - BS2D - BS3D - BS4D	3002731

GAS TRAIN ACCESSORIES

Seal control kit

To test the valve seals on the gas train a special "seal control kit" is available.



Seal control kit	
Burner	Kit Code
BS1D - BS2D - BS3D - BS4D	3010123



SPECIFICATION

A special index guides your choice of boiler from the various models available in the BSD series. Below there is a clear and detailed specification description of the product.

DESIGNATION OF SERIES

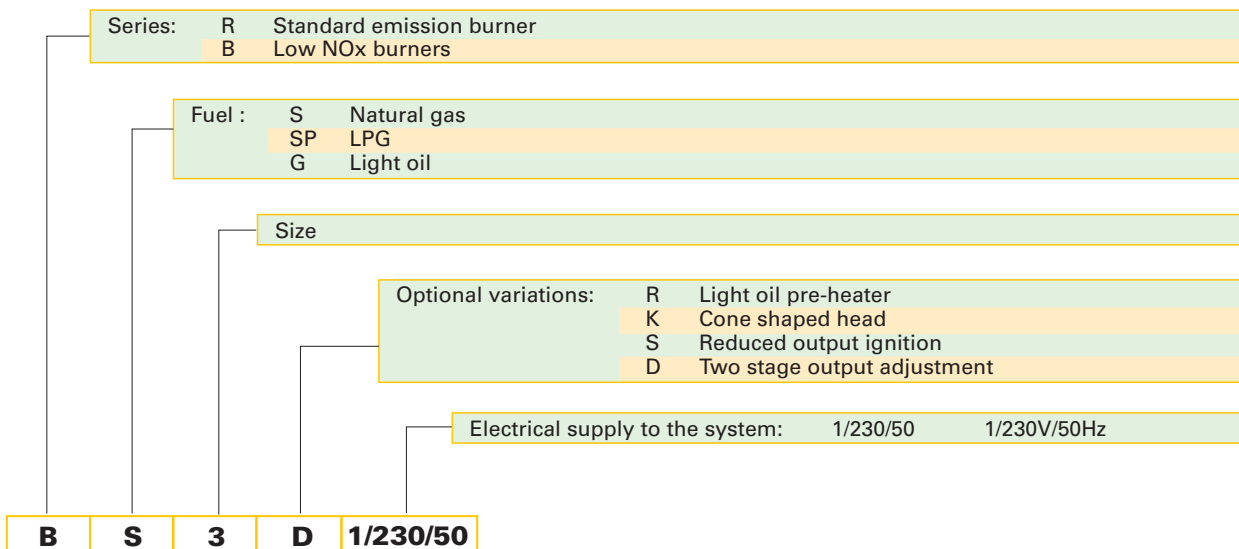

AVAILABLE BURNER MODELS

BS1D	1/230/50
BS2D	1/230/50
BS3D	1/230/50
BS4D	1/230/50

▶ PRODUCT SPECIFICATION

Burner:

Monoblock, gas burners, completely automatic, two stage operation, made up of:

- Fan with forward curve blades
- Cover lined with sound-proofing material
- Air damper, completely closed in stand by, driven by an electric servomotor
- Air damper with 1st and 2nd stage adjustment (2nd stage external adjustment, with no need to remove the cover)
- Single phase electric motor 230 V, 50 Hz
- Combustion head fitted with:
 - stainless steel head cone, resistant to high temperatures
 - ignition electrodes
 - ionisation probe
 - gas distributor
 - flame stability disk
- Flame inspection window
- Adjustable air pressure switch, with graduated selector, to guarantee burner lock out in the case of insufficient combustible air
- Microprocessor-based flame control panel, with diagnostic and remote reset functions
- Protection filter against radio interference (included into flame control panel)
- IP X0D (IP 40) electric protection level.

Gas train:

Fuel supply line in the Multibloc configuration, fitted with:

- Filter
- Pressure stabiliser
- Minimum gas pressure switch
- Safety valve
- Two stage working valve with ignition gas output regulator.

Approval:

- EN 676 standard
- LRV 92 standard.

Conforming to European Directives:

- 90/396/EEC (gas)
- 73/23/EEC (low voltage)
- 89/336/EEC (electromagnetic compatibility)
- 92/42/EEC (efficiency)

Conforming to:

- BImSchV 1996

Standard equipment

- Sliding flange
- Flange insulation screen
- Screws and nuts for fixing the flange to the boiler
- 7-pin plug
- 4-pin plug
- Remote control release kit
- Instruction handbook for installation, use and maintenance
- Spare parts catalogue.

Available accessories to be ordered separately:

- Extended head kit
- LPG kit
- Alternative combustion head kit
- Ground fault interrupter kit
- Multibloc rotation kit
- 7-pin plug kit
- Interface adapter kit
- Seal control kit.



RIELLO S.p.A. - Via Ing. Pilade Riello, 5 - 37048 San Pietro di Legnago (VR) Italy
Tel. ++39.0442630111 - Fax ++39.044221980

Internet: <http://www.rielloburners.com> - E-mail: info@rielloburners.com

Since the Company is constantly engaged in the production improvement, the aesthetic and dimensional features, the technical data, the equipment and the accessories can be changed.
This document contains confidential and proprietary information of RIELLO S.p.A.
Unless authorised, this information shall not be divulged, nor duplicated in whole or in part.

